

\$4.95 USD

Mostosoft Magazine

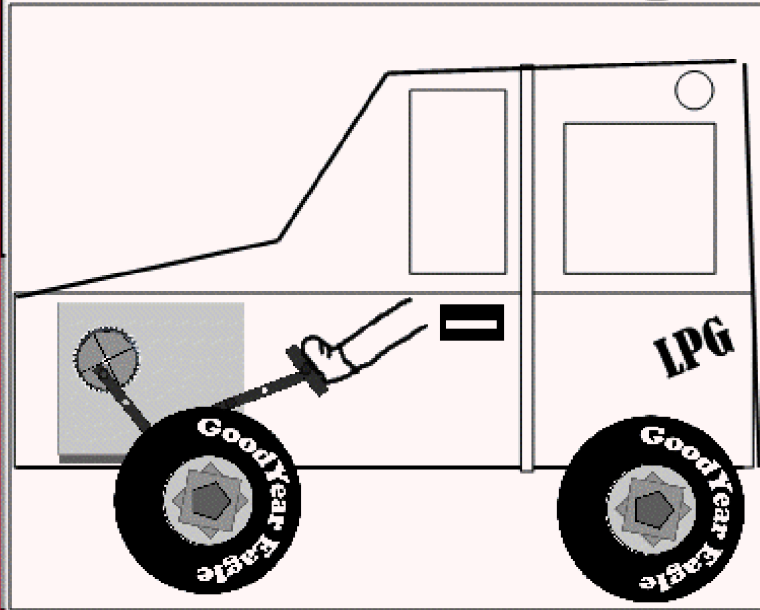

Motorola Video Phone

Linear Propulsion Gearing Arrives

Texting....LO L L8 D8 xaspr8ed1

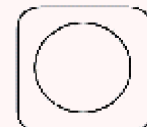
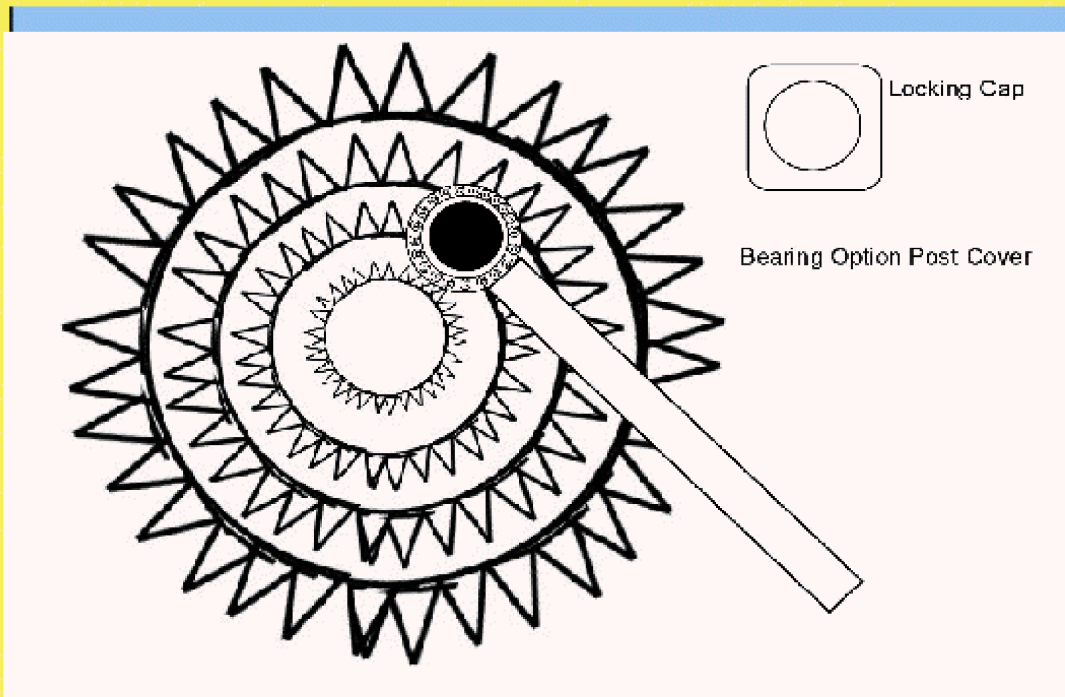

Locking Cap

Bearing Option Post Cover



The Official News Magazine of www.mostosoft.com



- *New Fiction and Video*
- *Daves Place Jokes*

May 2008

**VAN GOGH'S
EAR**

Mostovoy, WD

Excerpted text

The world arms race continues to this day. The Soviets and the Americans constructed vast arsenals during the cold war. The stockpiles continue to collect dust in both countries.

The nature of emerging world superpowers goes on. The economic might of Germany and Japan could provide all of the manufactured goods the world needs. The Germans and Japanese produce better steel, cars, computer memory, electronics, bicycles, television and wires.

The German economy produces half of the output of products from Europe accounting for 5 Trillion dollars with roughly 50 million people. The United States vaunted 10 Trillion dollar economy covers roughly 6 times more people at 300 Million.

The Japanese productivity provides the life all Americans take for granted. The office complex in America changed over the last 27 years since 1980. First in 1980 the corporate world relied on American trained personnel.

The American in the office complex functions today as the spy. Those that create products in the United States live in their mind in China, India or Russia.

—

The United States lives for money. The money management game attracts the fine and savvy minds from all the schools in the land. Managing money and risk prove that the skim on shell games provides better income than the game itself.

Some food processing goes on with imported stainless steel holding tanks but so what. Most of the labor in food processing goes to the minority poor in America. Sixty percent, (60%) of American produce gets harvested by immigrant labor. The agrarian economy in South Carolina in 1855 contained about the same number of slaves to support the real citizens of the state. The same goes true for Texas cotton picking hands.

To accept the country became bankrupt by insider trading makes sense. Each company contained assets that were sold off for a profit to end American business. Ivan Boesky and Michael Milkin got caught while the millions of others that found leveraged buyouts and junk bond trading exciting walked away from America's Las Vegas style marketplace.

In Las Vegas style business a consumer gets choices to put their wager down on a car company product at the place they see fit. The command economy lines the pockets of the rich and demeans the slave ethic.

Human rights violations take place every day in America and the whole world watches to see how long the propped up dollar holds in the world before the final swoop and death blow to the backwards American leadership.

The Blind Pig
Café

Ann Arbor

Ricks
Café American

Ann Arbor

Good Time

Charlies

The Count of Anitipasti
Upstairs



OUR Staff Gets better every year. Sony

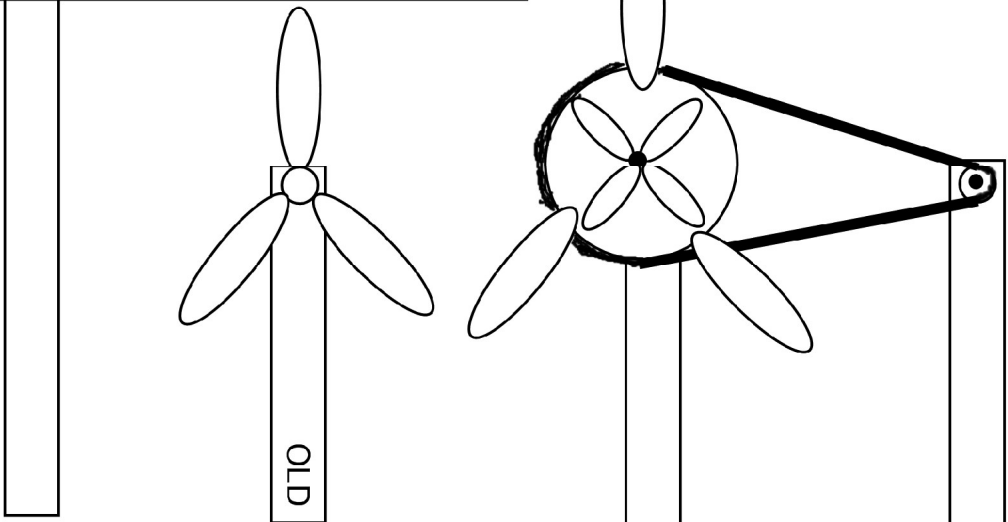

GEARED
WINDMILL FARM

A small icon of a windmill with a square body and a pointed roof, positioned to the right of the text.

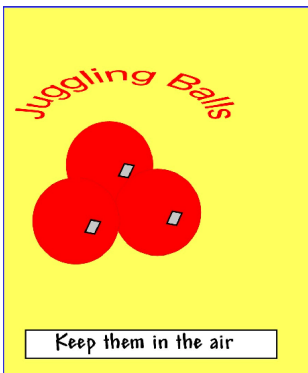

I don't have anything in my head sometimes, she exclaimed. When smart people do something I feel like people live smart. Couldn't you do something without using the bug? She mused. "I don't know what else to do? The Cricket user peeped. "I can't golf or screw up?", The tough un-shampooed truer bespoke. "When you golf or screw up, what lips do you use?" she asked not really hoping for an answer.

"That some guy might come home and tell me he hit a good shot never worked for me." She averred.

"I wanted to here about some ones big one, and get teased." The red shoe wearer smiled out. "Here comes one." the meek female exclaimed.

"I don't know what to do." She faked the quick response.

:"I can't get up again for three seconds without Bruce Smith saying die young." The fretting one opined.

:"Once you are with the birds, you are with the birds." The golfing executive boomed.

American business relies on both a professional plan and staff. The economy works and Mitt Romney looks like an American business leader. The symbol of Mitt implies a respect for the office and the male life.

Women and minority issues never permeate the forethought of the Mitt Romney's of this world and they need not. The softness a female candidate takes on her own kind as well as minority make them unfit to cold American life.

A Man can be cold on immigrants, minorities and women. The man in America can come home from work and know how business looks from the way Mitt sounds. Men can be charming and soothing and he can be tough on issues.

Those that want single issue candidates will always vote for the issue they feel strongly about. The issue of fair play seems to go only one way for those with significant others.

The nature that the man wants Mexicans to live in Mexico and a man and a woman to be the definition of marriage ring truly in the Boston republicans mind. Lest America forget someone needs to show the guest the door when they will not leave. The airport security from Poland, China, Africa and Mexico look so easy the commander of the defense forces of these countries fly right in past security to run local wars.

I ask you who would stop this Man, Barak Obama or Hillary Clinton.

The country allowed visitors as long as you had tourist and worker visas to come here. This public toilet dress up game needs to stop. Could I get you to say You Betcha.

The Quad Design

By

Bill Mostovoy

An Engineer from the University of Michigan

Note: The state of Michigan builds more cars than any state in the union.



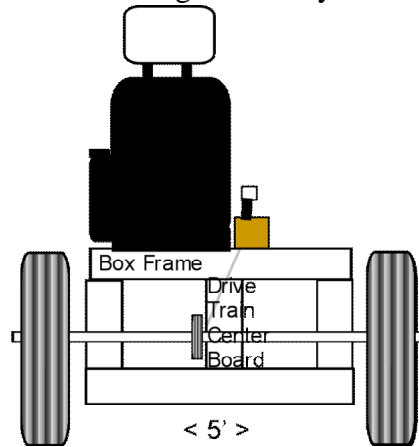

The Box frame consists of four high strength polymer rods. The 5 part frame allows for the linear propulsion turbocoil system to function on the correct plane with the drive wheels.

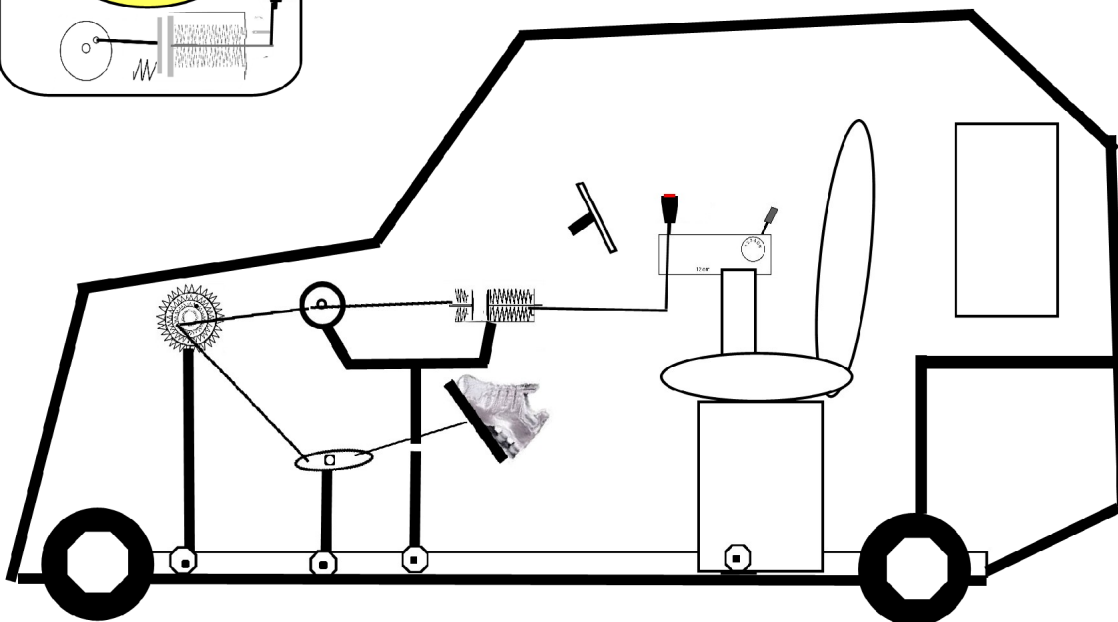
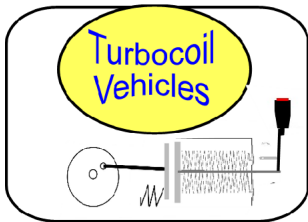

In this view the vehicle sits with the box frame hidden with the exposed turbocoil linear propulsion "Grip and Rip" model of car operation

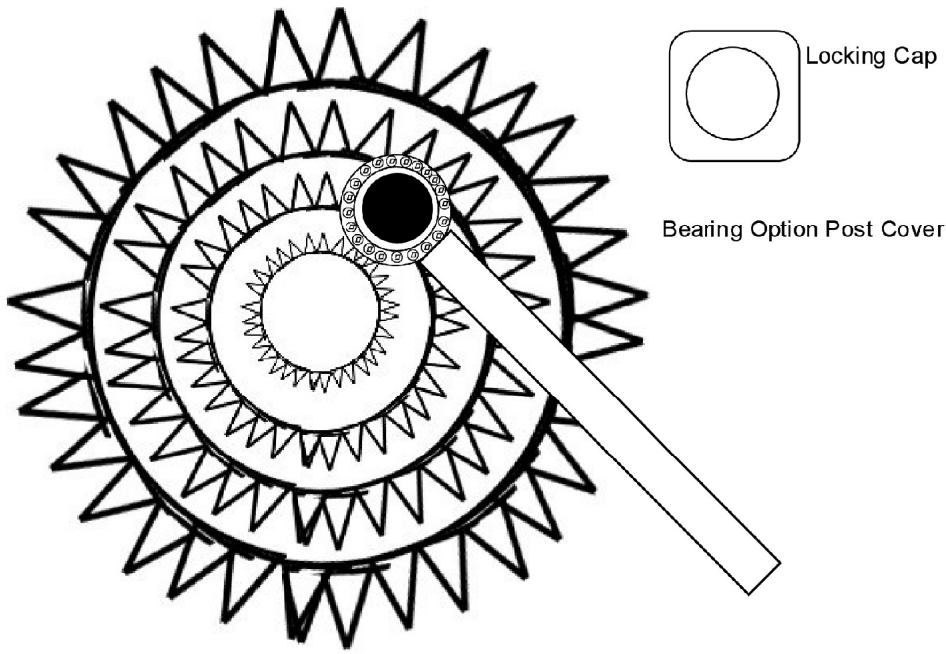

Here the view of the front spindle gear shows the bearing cover loose fitting post exposed with the locking cap off so that on side to side motion the loose post stays in place.

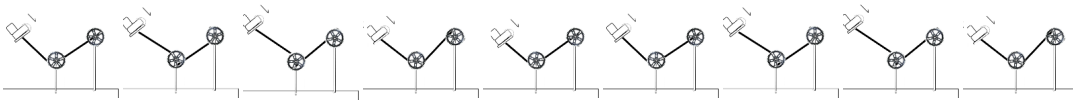

Mechanical Motor

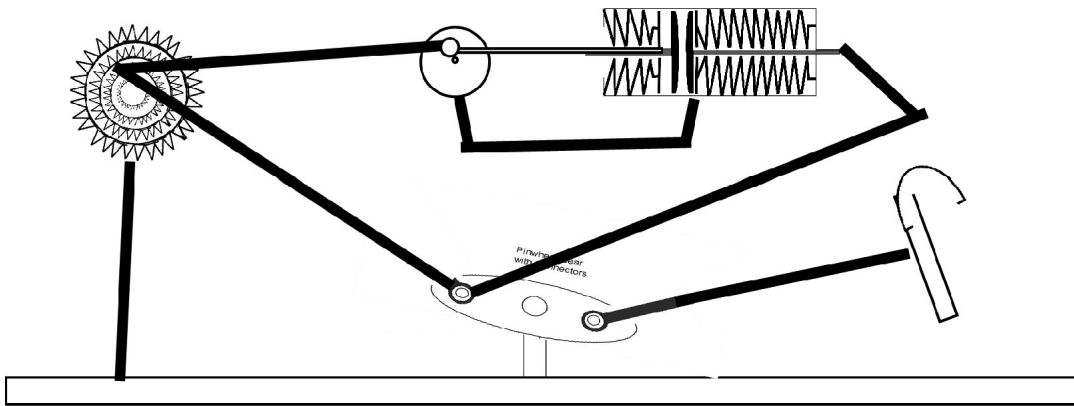

In this design automatic turbocoil oscillation takes the place of the manual control “Grip and Rip” model.

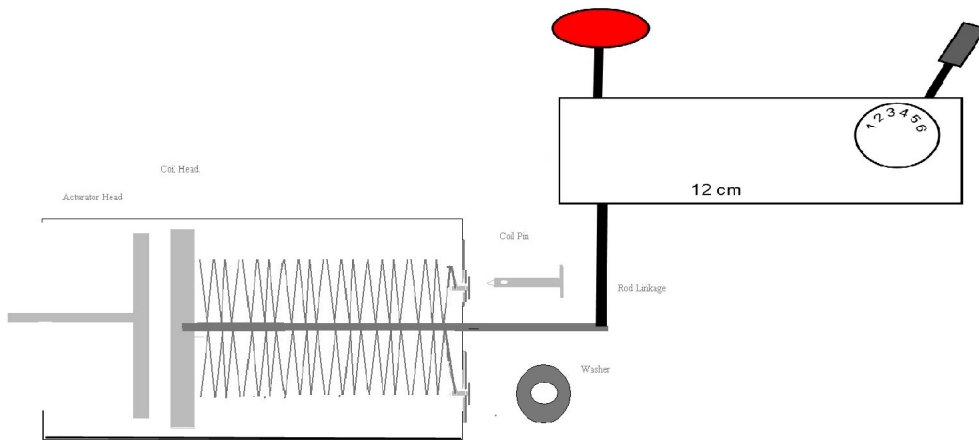

The gear box houses the shifter for the rear derail. Six (6) gear positions indicate (6) sprockets on the rear spindle.

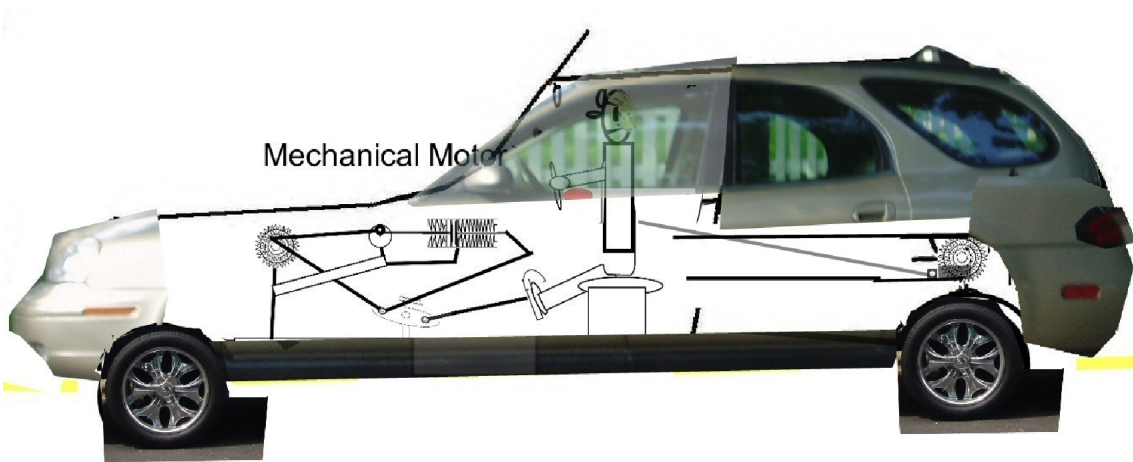

Projected top end speed 100mph (160kph)
Similar to a Ford Taurus Station Wagon.

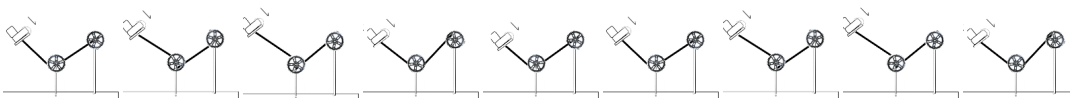

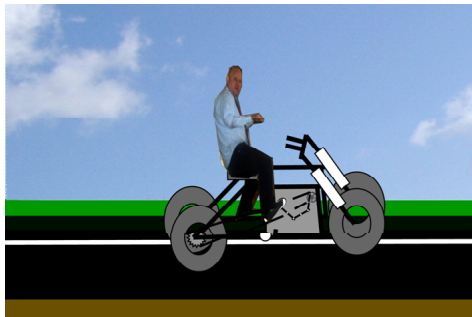
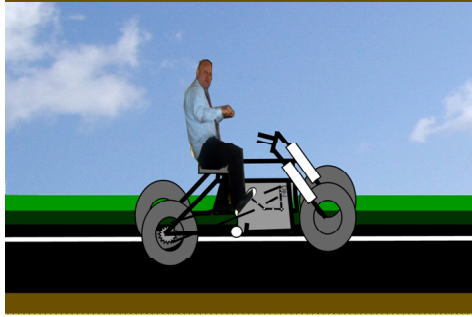
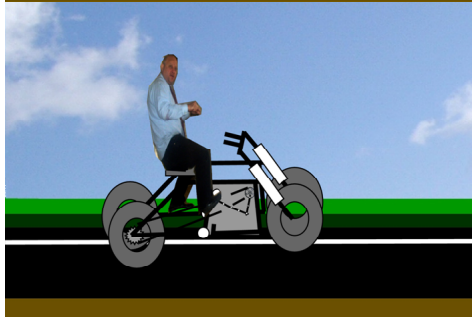
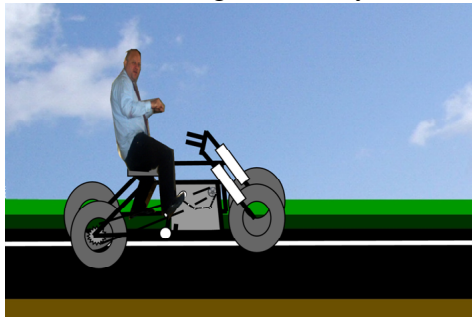
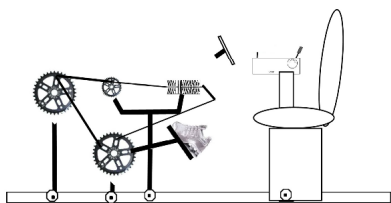
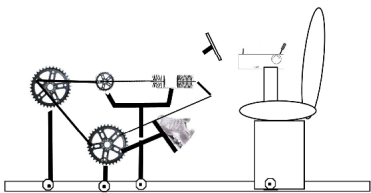
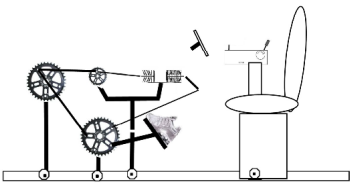
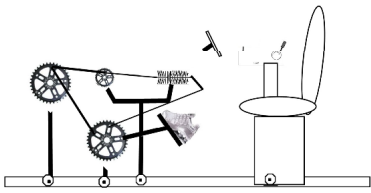

**VAN GOGH'S
EAR****Mostovoy, WD**

Excerpted... (The rich get richer and better TV violence, the poor get pruned)

The effort of life for winning draws partisan dreams. Partisanship creates an aura of winning and belongingness for all those on one side. Some individuals believed in the good play theory of enjoying life. An opposing player in sports may score in a great way and as a fan of the game may enjoy the fact that a quality score took place.

Partisans hate the score of the opposing player regardless of the quality of the dinger, goal or touchdown.

Partisanship politics creates hate and enemyship. The feud between Republicans and Democrats costs more than hard feelings in a terrorist age.

If you give up a life you knew from the university or the job because of political responses the good people of Russia, China, Mexico and Arab lands take the life as an inroad to destroy all of America.

If you hate an American because they care about the process the country will fail. The response to partisan politics at the point of extorted visual evidence remains crime and revolt. Those that do not have everything do not get American politics.

If you have your basics and extras the time to pass the word that everything domestically is not covered you will do your country a service.

Unemployment amongst the poor stands at fifty percent. Millions of people forgo food each day. Handgun violence creates unrest in every urban area.

To stress the divisive point, crimes, gangs and drugs stem from poverty and educational divides. Those in gated communities, and these are great people, miss the fact that suburban police departments see far more than they ever did in terms of poverty crimes.

Of course each crime goes to the system and the justice system processes so many the criminals arise to fill every available jail bed.

When the man someone knows goes to crime jail, ten more fight to see who gets the turf to deliver the drugs to the next suburban party.

Shield and Badge Theory

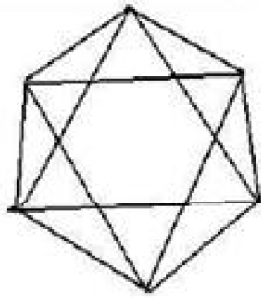

The diamond of religion contains the following Earthly Love, Order, Controlled Expression, Fathers and Mothers, Sons, Suns and Stars, Good Cheer and Self. Ordering depends on Epistimologie of Language and Time.



Printing out a snack cabinet sign enhances at home food.
For bonus points charge yourself for refill orders.



The Sony Vaio comes with a camera built in



Hard Drives upped in size to 1TB going for \$1,000

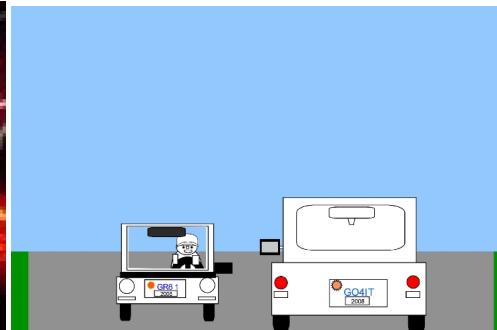



Upon the rocky shore.

Let Freedom reign oer gloried flight
The seabird sands the Frolickers nights fight

The daily grind mixes dust
To show the world that life does trust

The Swallows Gale Force Winds
Leave Free Our Sins

Others dance and twist sublime
The earth below finds the time

To ebb and flow another day
Each and every to her gray

Five fingers on each hand
To return from beach to sand

Every night the glimmer moon
Lifes short journey ends to soon

Author WDM

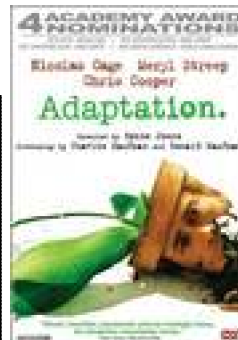
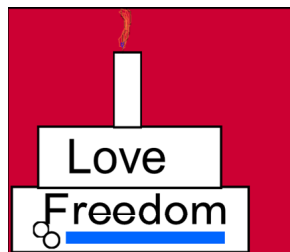

Mr. Mostosoft Authored Adaptation as Akiva Goldman

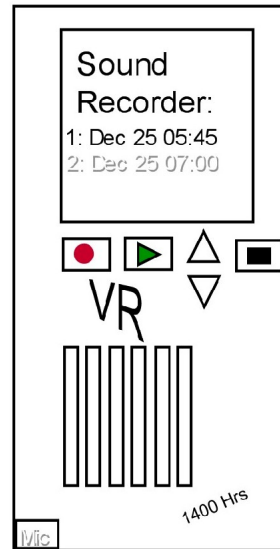

Most people turn them on for all dates at home.



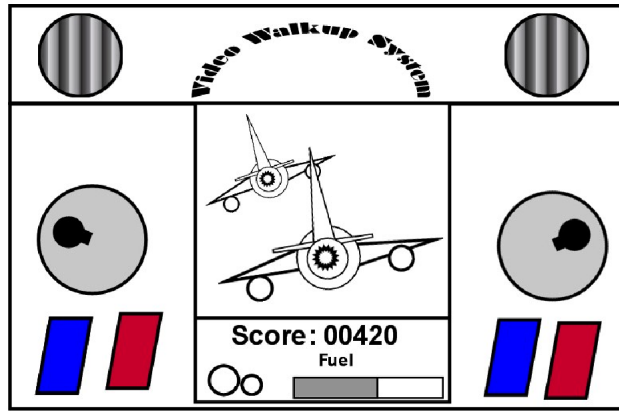

Video games rule the world.



Lionardo



Vincent



Leonardo-Vincent-Bill



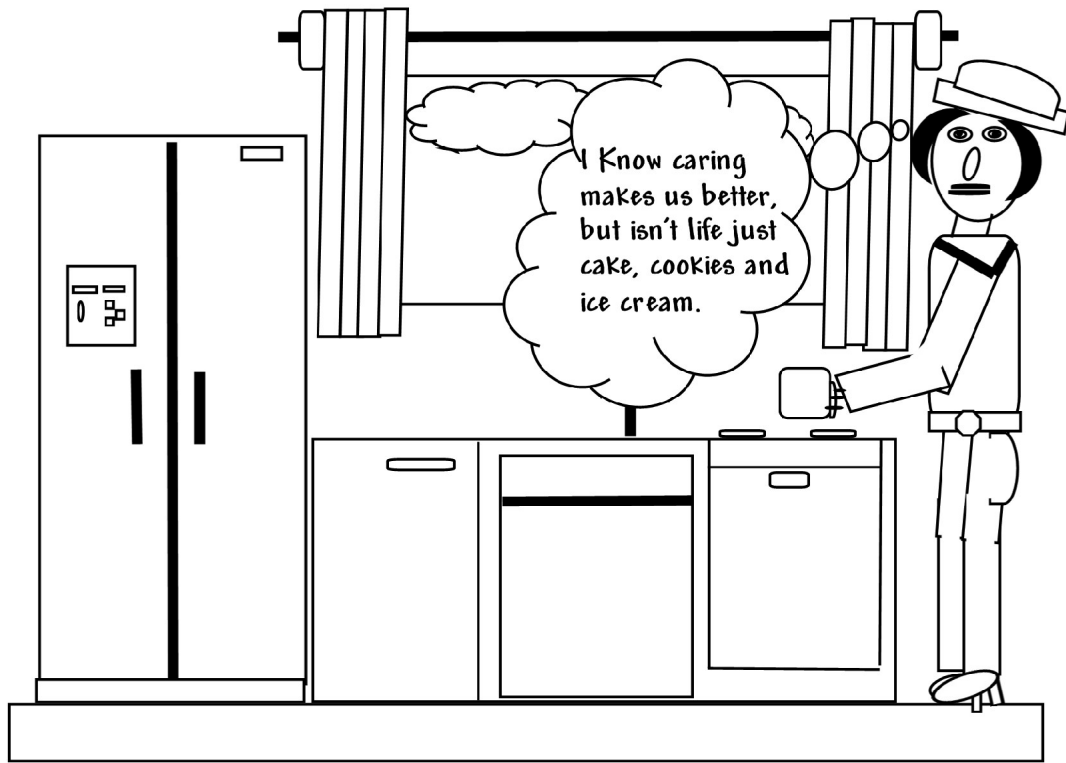

Apple Computer Mac Mini



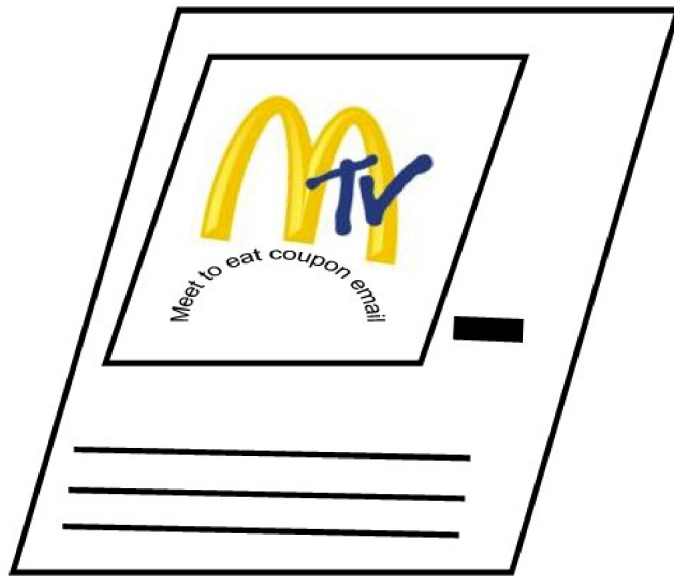
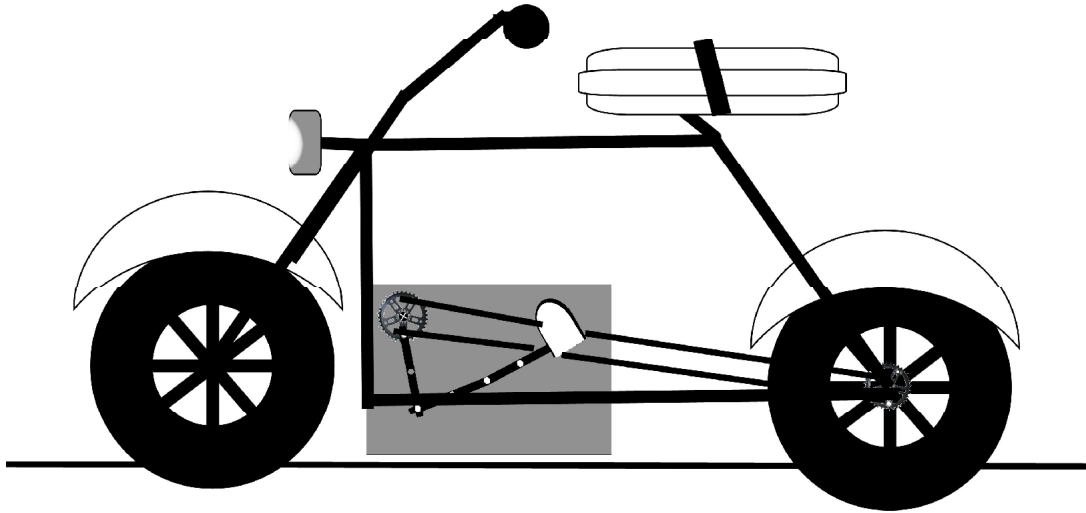

Send a coupon with a 255 character message. E
system individually owned and operated

McEmail

ach McEmail

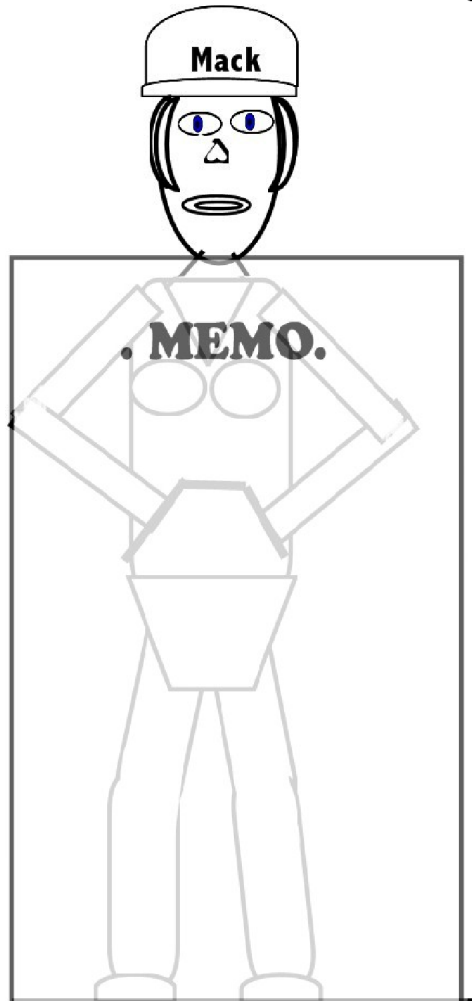
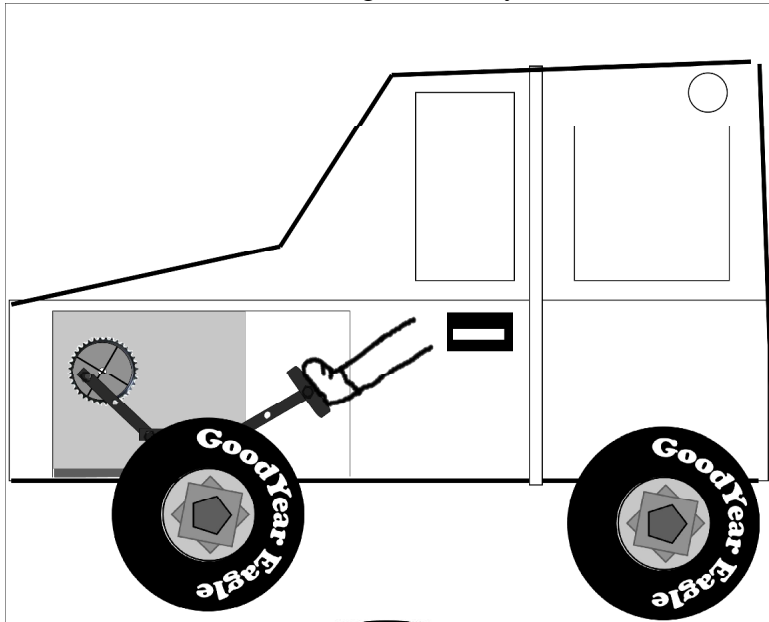

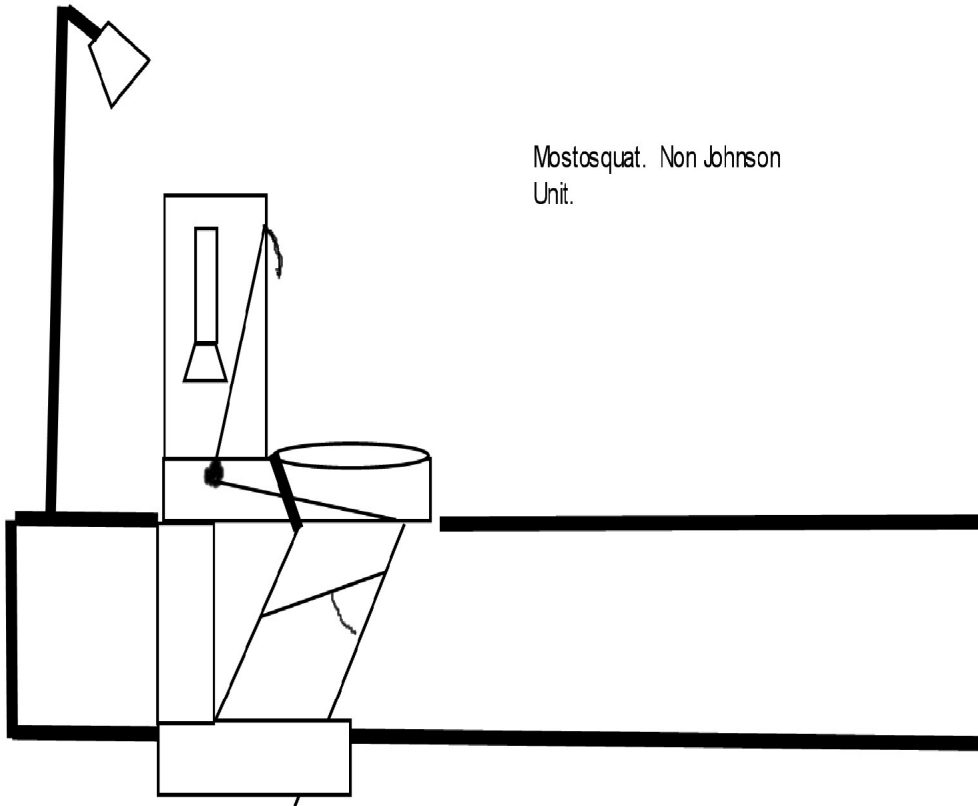

Mostosquat. Non Johnson
Unit.

The back side scrape is the key to the new style toilet. Pre-Fill to see waste as normal. On completion use the sprayer. Auto spraying defeats the purpose. Women said life was to easy and had nothing to complain about. So I have given them the have you prefilled the bowl dear.



See the new film from Mostosoft Films.