

\$4.95 USD

Mostosoft Magazine

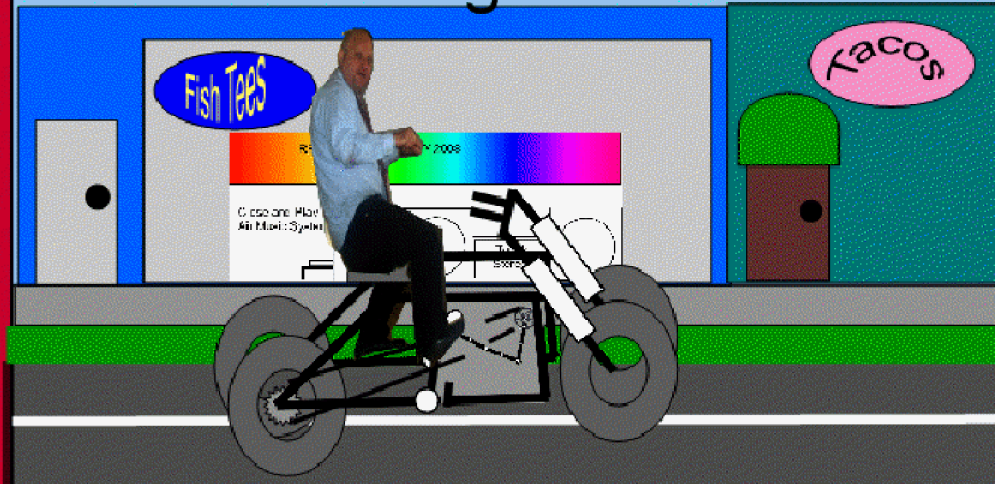

The Mostosoft Beach Cruiser Arrives

VAN GOGH'S EAR

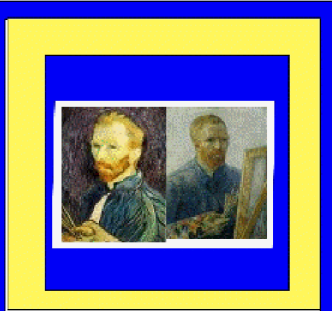

● W D Mostovoy 

The epilogue to the 20th century.

Anyman War

Featuring

WD Mostovoy

A Docu-Comedy



- *New Fiction and Video*
- *Daves Place Jokes*

April 2008

VAN GOGH'S EAR

Mostovoy, WD

Excerpted text

The edge of the call exacerbates the calm break forced upon the mind. Many left with the photo firmly on the mantle reminding those that actually paid attention the account funds would go to the photo in the frame. The frame tells two tales. The broken board and broken bread earn the account with Saint Peter in heaven.

Having taken heaven on earth with the photo in the frame the tomorrow of tomorrows of cream pies and grandchildren birthday gifts of toys and treats ebbs with instant gratification powders of truth.

The lying and duplicity reach maturity for both in that the middle aged pulled the same lies with the now sexy senior citizens. The change of address the first time the VW pulled in and out of Fishkill New York, left the micro-bus with no where to go but near Fresno. The raisin people looked easy from near those Woodstock farms.

The pre-packaged stuff goes for much more now and no one can care for reasons that caring for the miniscule leads to convincing on great matters of state. The photo in the frame of Dorian Grey tells the tale of the truest Faustian bargain ever made.

The alarm buzzes and everyone awakes electric today. Advanced losses and corporate raider kids raid others homes much as the old Boeskies and Milkins did in the 80's. Realizing a home operates at a loss and has two car keys and a mortgage in arrears leaves the EBA, elementary business administration degree with the poison drugging and liquidation principle with those two cars and the sale of the house. Think about it the micro-bus group whined, for a mere few more video gamers, quality thoughts disappeared for bowel inspectors with an eye for infection.

A U-C education goes for say 4 decent cars. The photo in the frame with a modest buildup can get more from the polluted keeper of the frame. The political wedge issue and rivalry game adds fuel to the fire and the young EBA can go internet textbook on the move-out kill (MOK). The MOK connection to the military never made a difference before the terror attacks, now the bubble looks bubbled over.

Champagne, caviar and the death of others leads to the greatest disconnect a Bastille storming citizen could want. The Orwell book sat in the basement of books in Fishkill and some picked it up not long ago. Thanks for agreeing George that some pigs are more equal then others. The animal farm goes on. The jungle war fights with teeth hunting and eating pigs, no one knows what a rocker will prefer.

<p>The Blind Pig Café</p> <p>Ann Arbor</p>	<p>Ricks Café American</p> <p>Ann Arbor</p>	<p>Good Time Charlies</p> <p>The Count of Anitipasti Upstairs</p>
--	---	---



ANYWHERE- AND ANYTIME



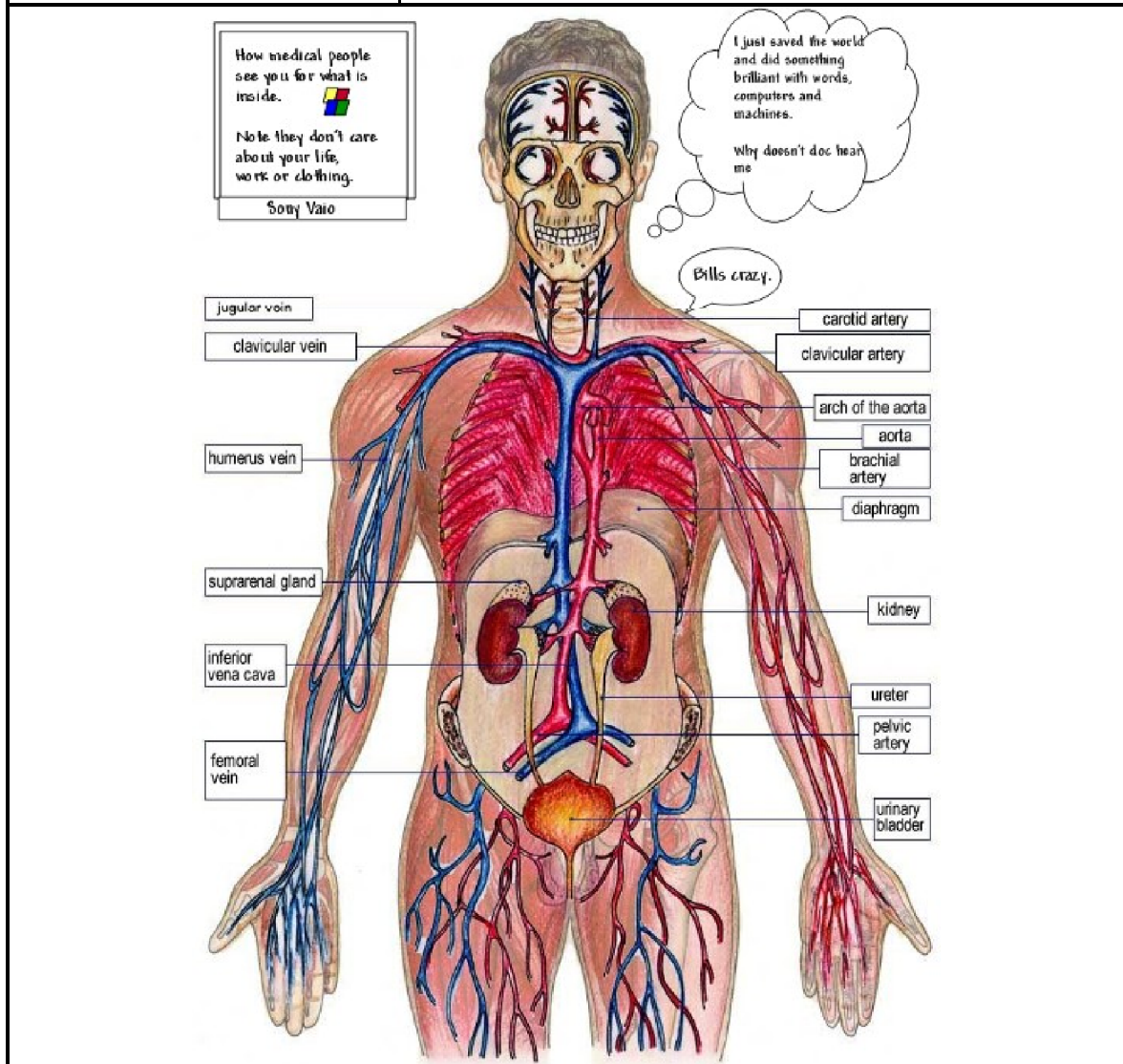
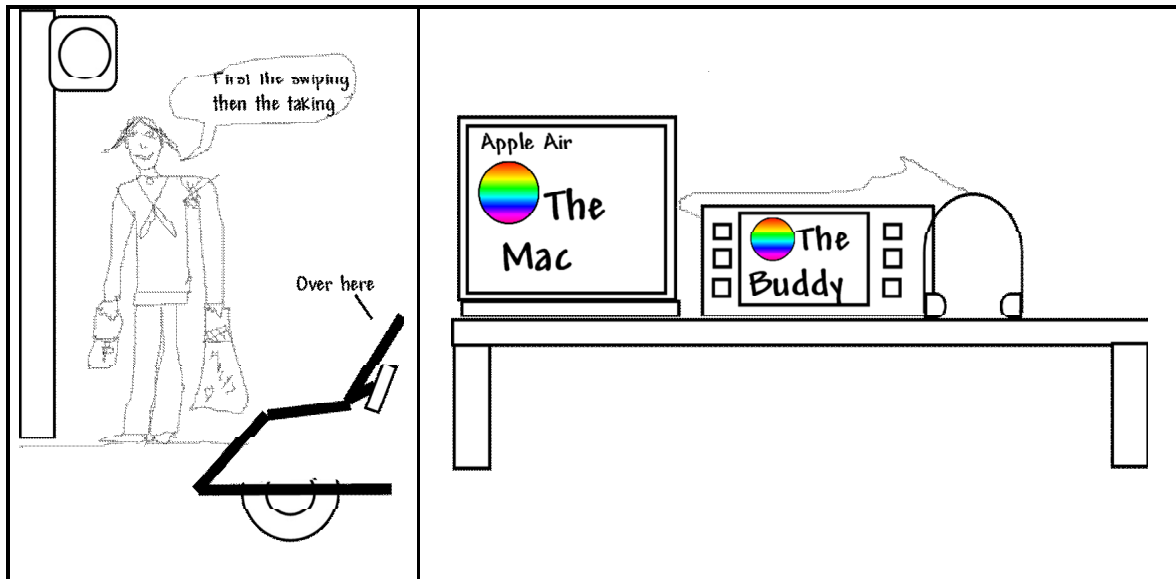

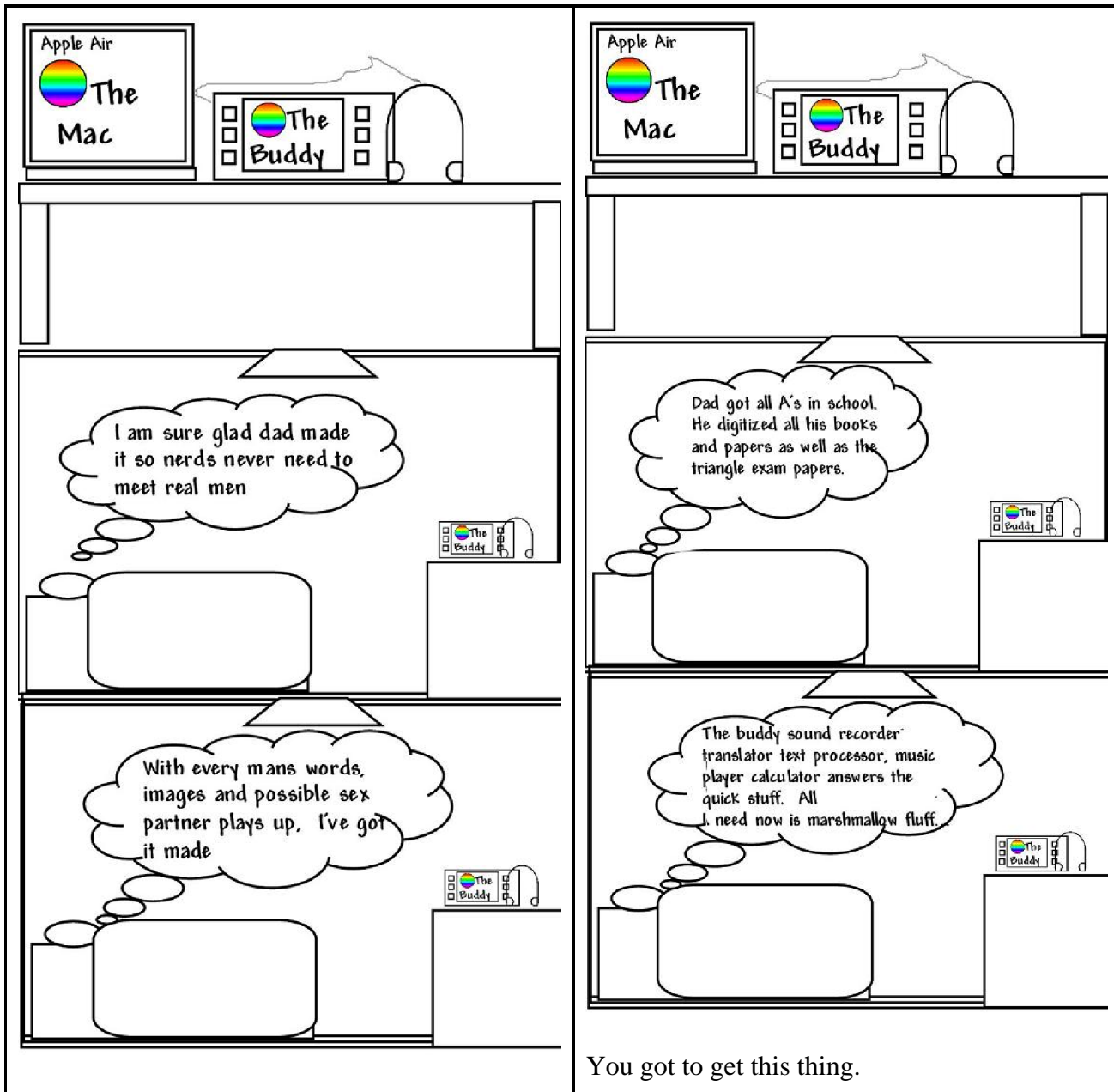

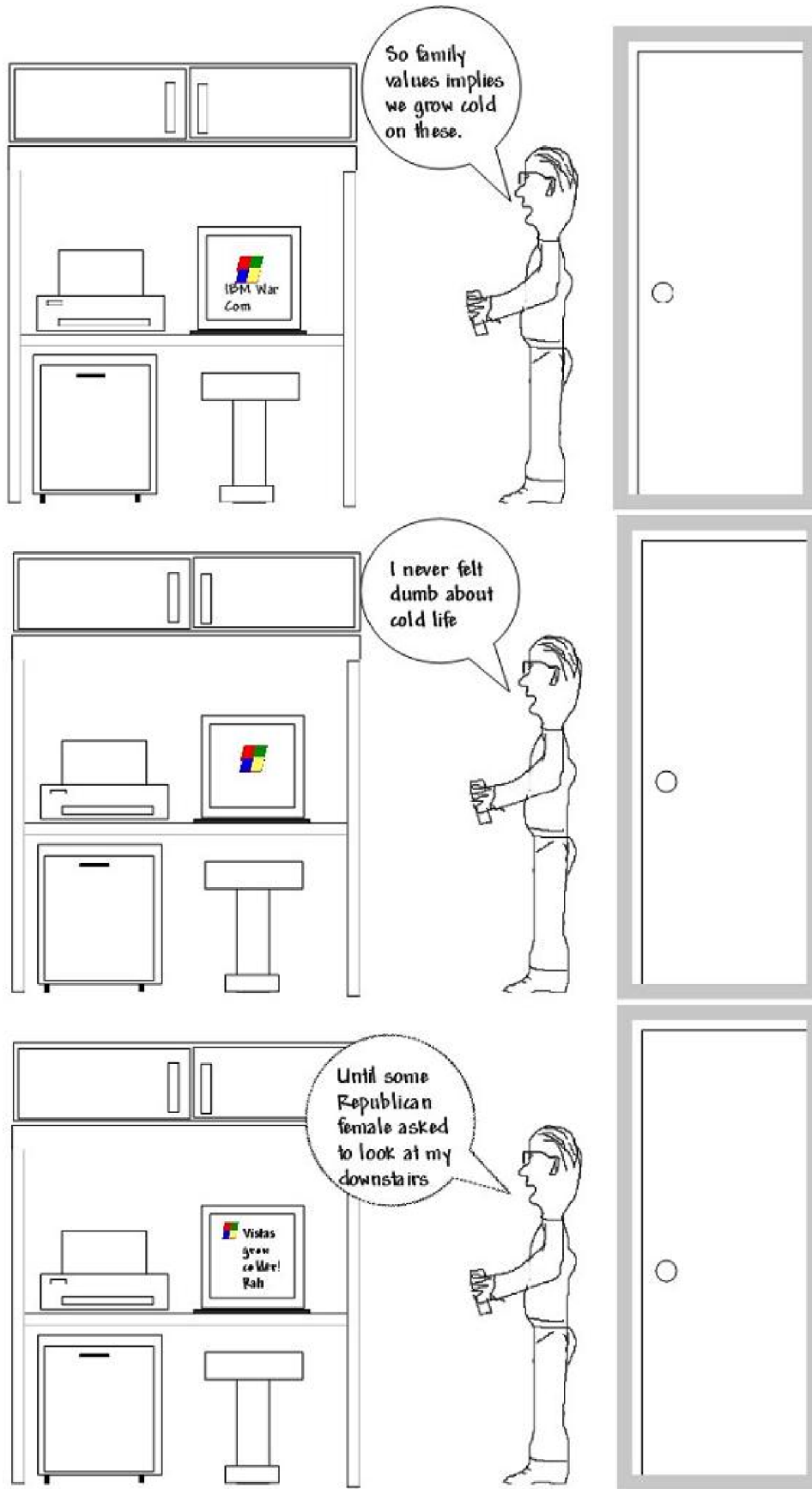

VAN GOGH'S EAR

Mostovoy, WD

Excerpted... (The rich get richer and better TV violence, the poor get pregnant)

In a world of conflicting moralities the conflict for moral authority degrades and denigrates the republic into the morass of morality baiting with the reward of eliminating a weaker physical morality. An absolute morality of self interested communal life tending towards tones of non-violence and intellect driven morality decayed with visual testimony in regards to communicative skills. The manner of being while relating a point of view led to the absolute truth of the human form.

The absolute truth relegated to the holy grail of the intellect proved for certain, that the input of an event leads to further inputs and outputs with regards to self enhancement and body to world outflow. The gift of exchange of words for honor left the world searching for the truth that would win a gift of a further word and financial exchange. Having expunged the true word passing in the non questioning acceptance phase of verbal exchange the words that creep into the home come not from the enemy down the block, they come from what was thought to be safe and edited television content.

The past world, confusing as it was, relied on the knowledge that information sources should be noted and accounted for. Each individual home attained wealth at one time by making an enemy of one sort or another. The inevitability of conflict in an era of openness led to absolute false statements known as falses. A false absolute for example would be, "If you drink water from the lake you will vomit." led to pranks with minute poison at the next meal by a prankster. Other absolute falses in terms of self defense knowledge and meaning, known as reads to the false purveyors, convey fear in regards to false purveyor busting with physical strength of deceptive and drugged surrender to the lesser evil. The greater good in false purveyor world means the lesser evil in that those with the greater good procreate dividing the existing wealth to return to a least common denominator seen in Asia and the Pacific Rim.

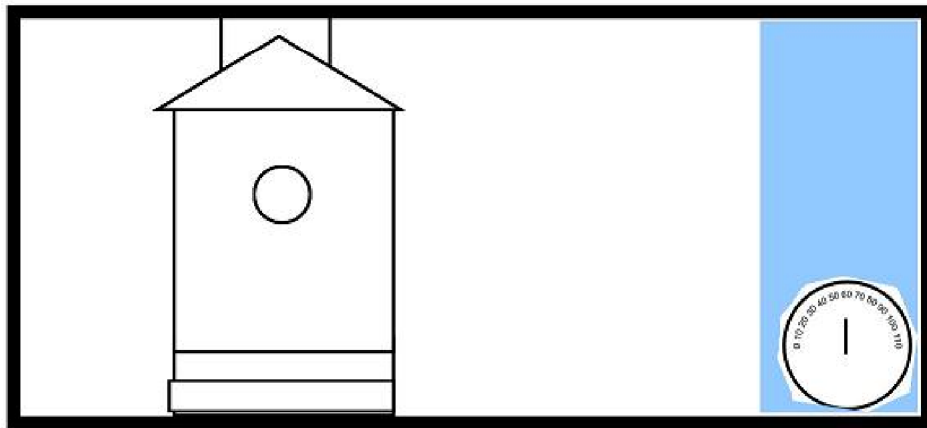



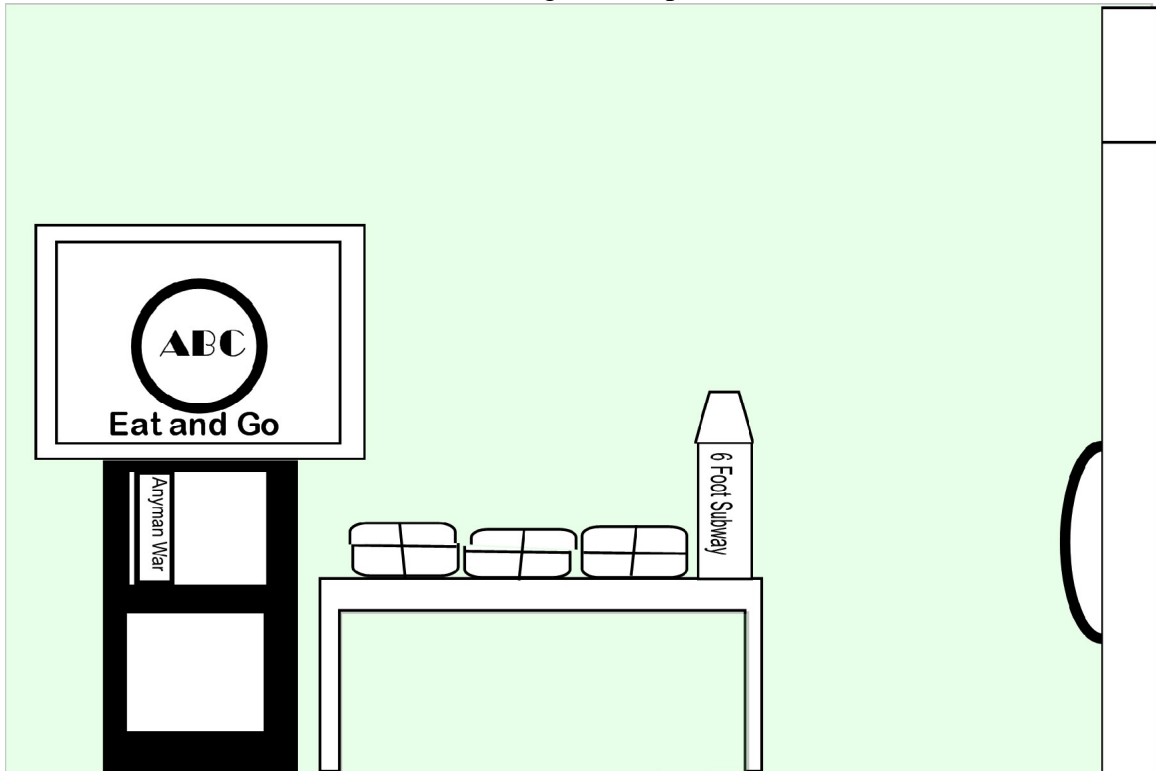

U.S. ARMY
THE REPUBLICANS ALLY IN JEW KILLING
1 HIGH SCHOOL PER 10 PEOPLE
1 COLLEGE PERSON PER 10 PEOPLE

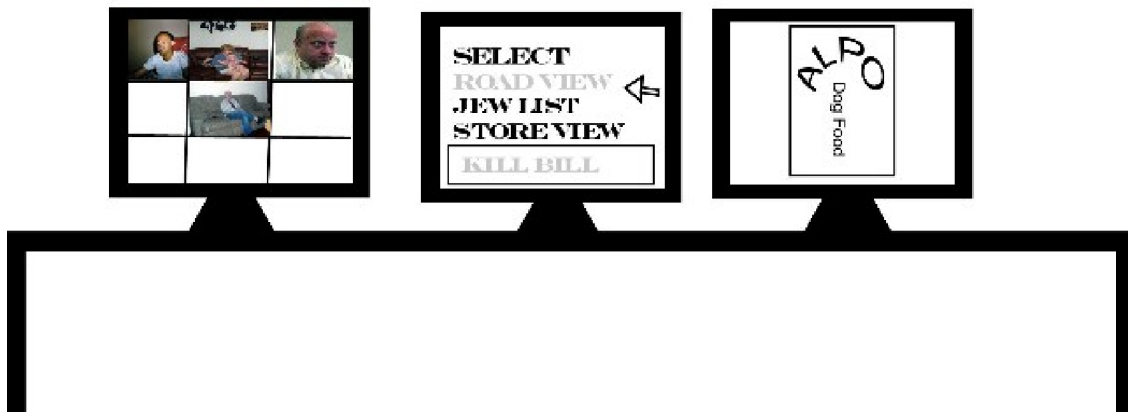

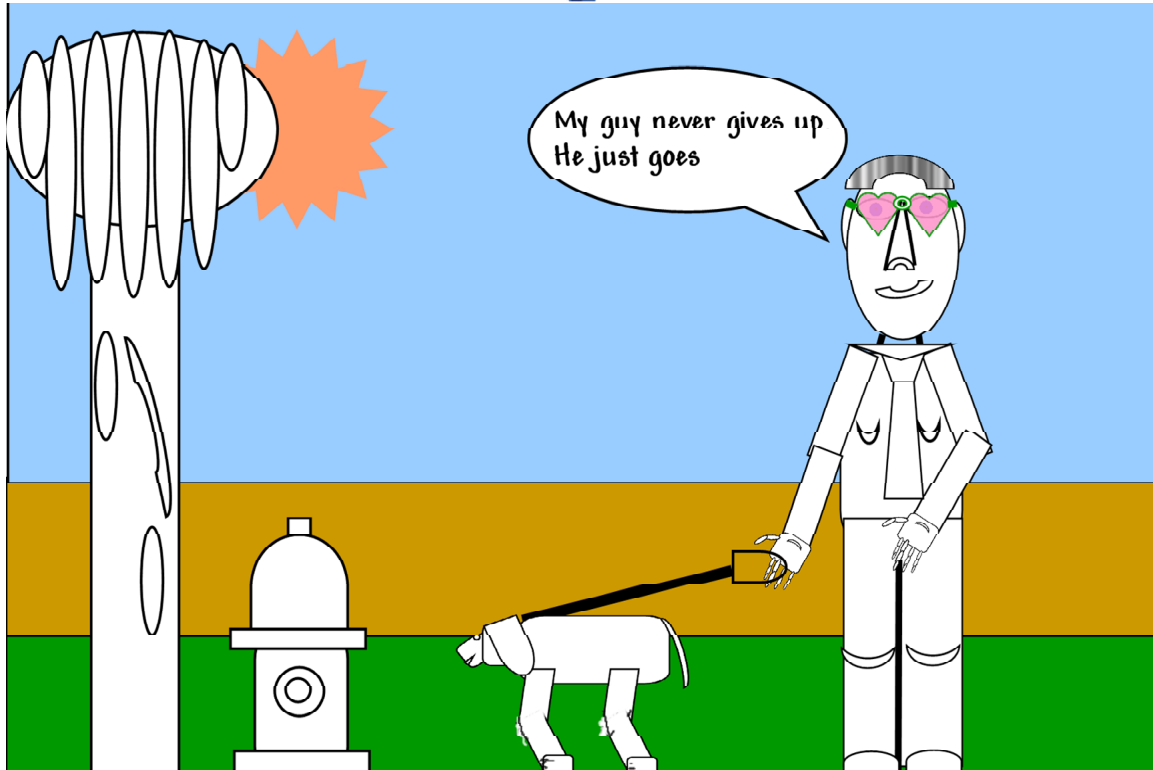
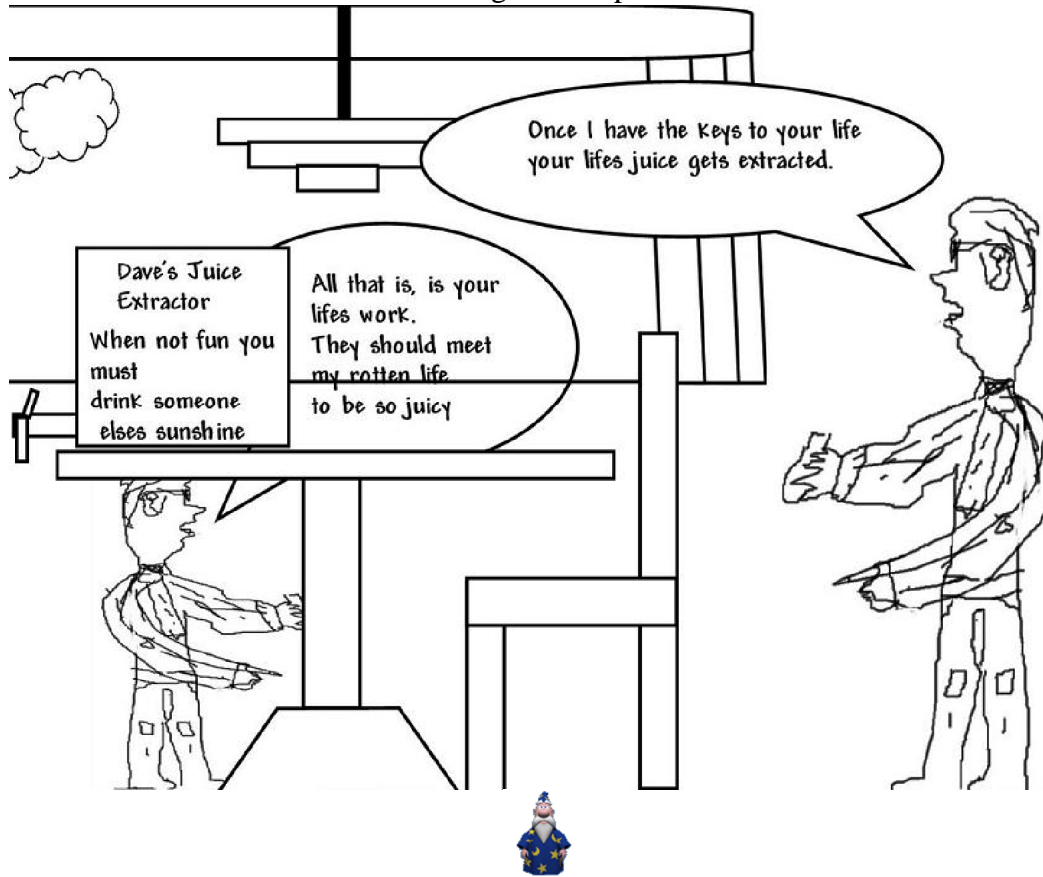

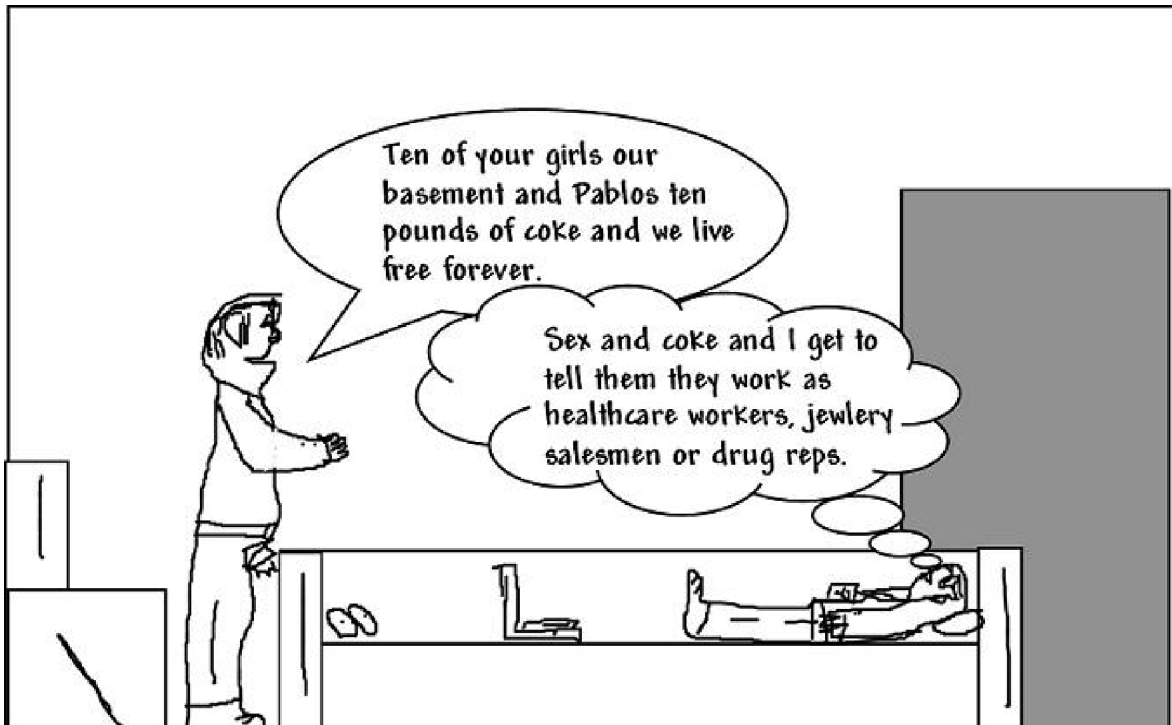
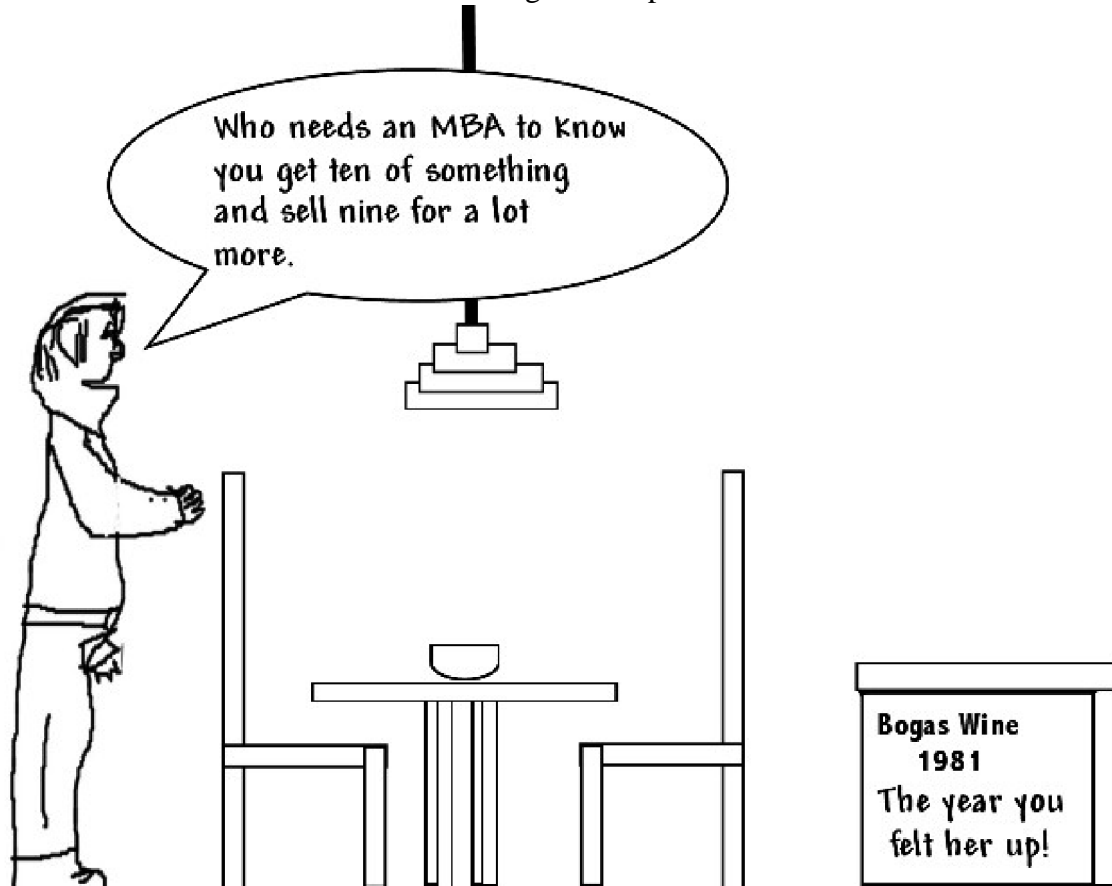

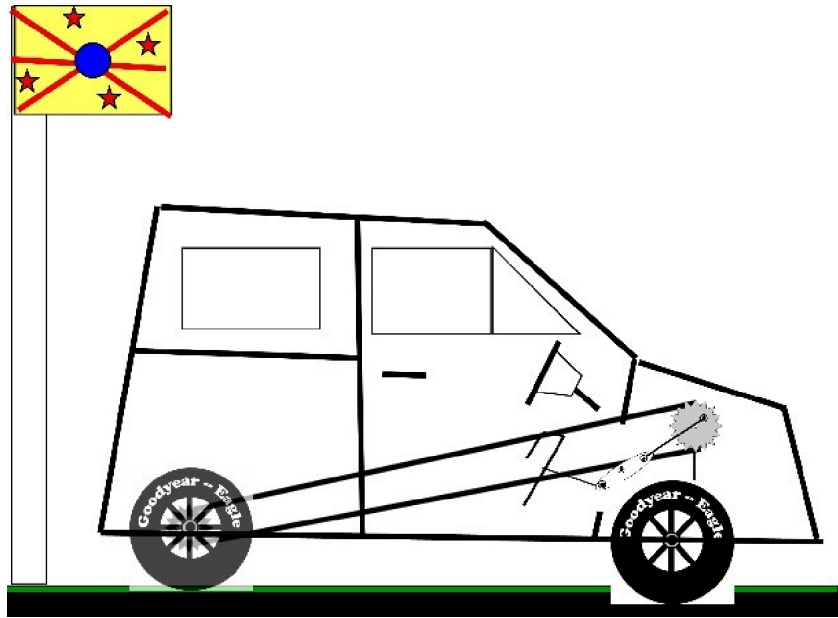

Electrical Pump Piston

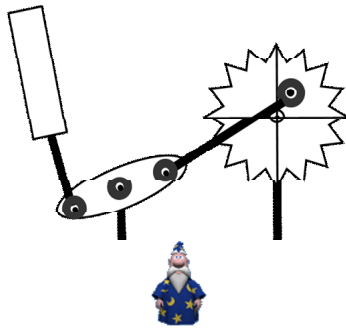

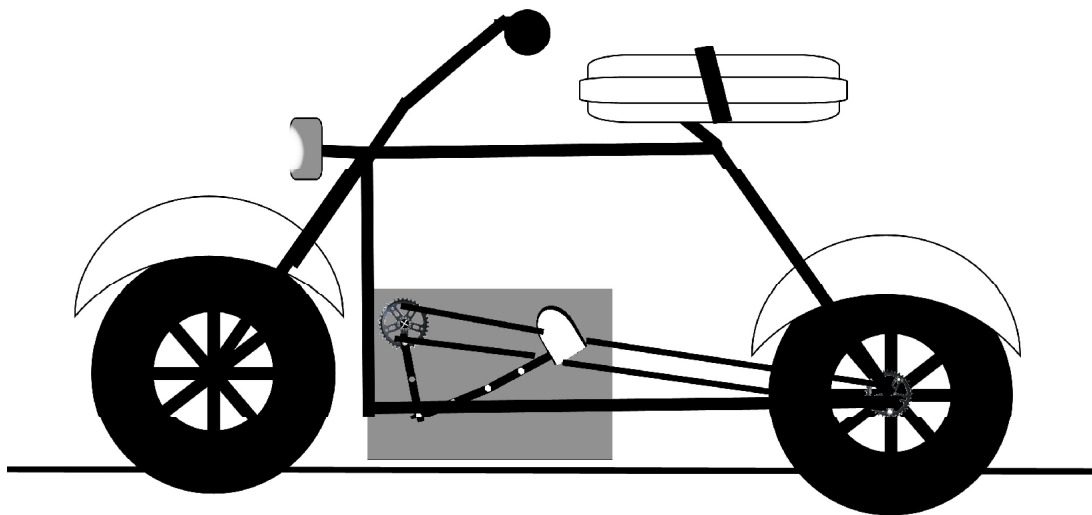
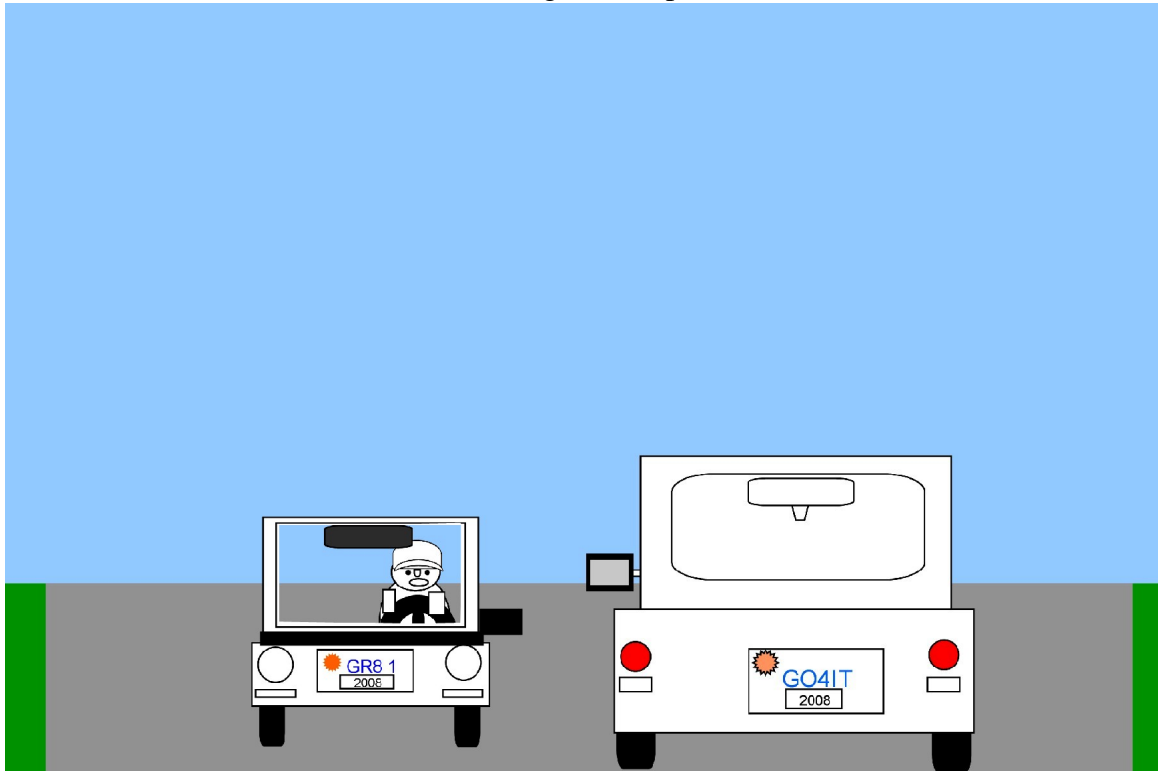

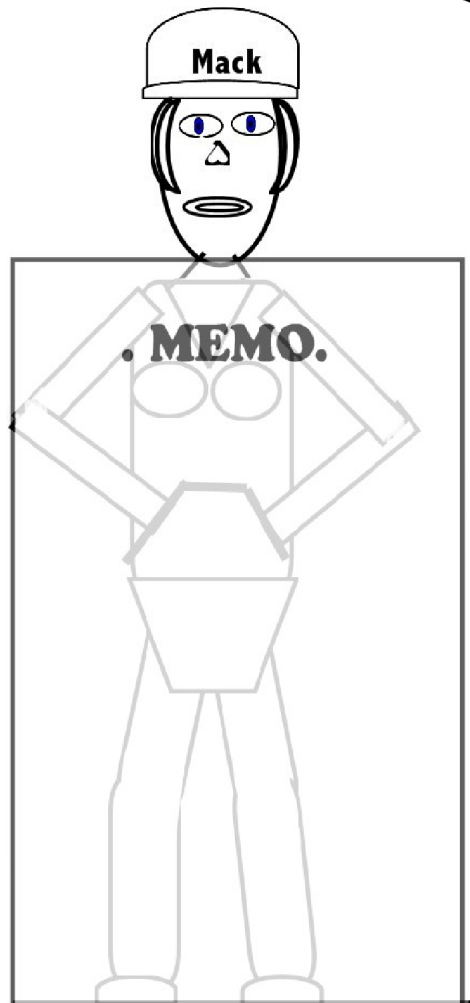
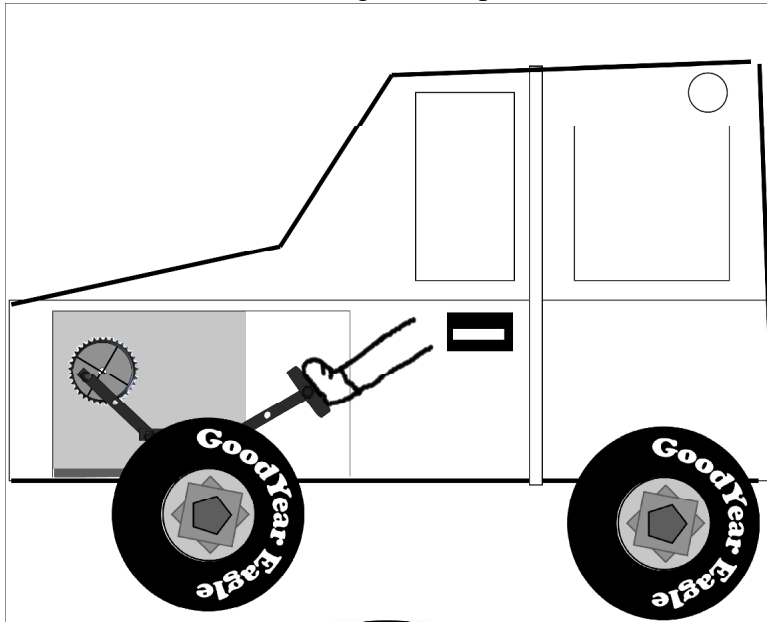

Water Saver toilet. Can run wet or dry.

Pre and Post fill for wet use

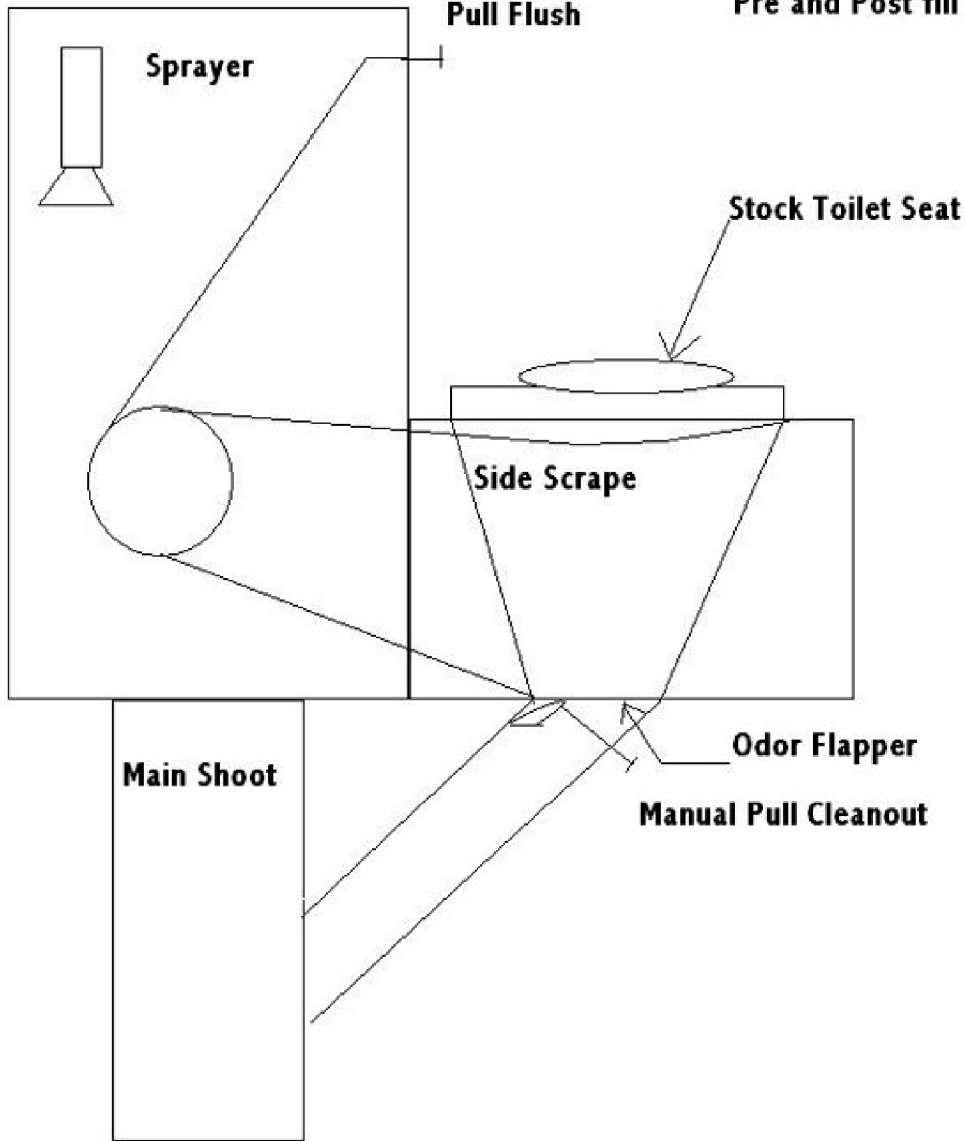

In the digital era each man must be a president.

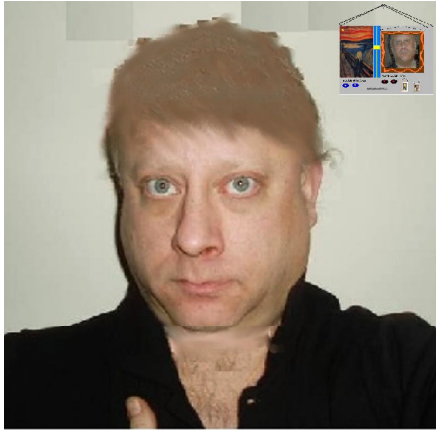

Bill Headroom seeks the presidency as one who has your bits covered.



Former Michigan governor Romney had a son Mitt, the Massachusetts Governor the technically aware support.

