

\$4.95 USD

Mostosoft Magazine



Desktop Terabyte drives

MOSTOSOFT ANIMATION FLYS

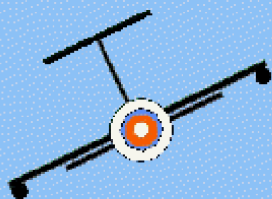

The Official News Magazine of www.mostosoft.com



- *New Fiction and Video*
- *Daves Place Jokes*

March 2008

VAN GOGH'S EAR

Mostovoy, WD

Excerpted text

The essential nature of philosophical thought that the will to power and government rests with the connected conceptually lead the vision for the republic. The republic space defined firmly with border regulations led to the nation state republic inclusive of defensive structure poverty ridden lives. The defensive structure lives order through the powerful body weapon dual.

The power struggle in the civilly structured gainful payment barter life in the promotional past bodily strike force technology through willful dedication to just killings allow the upward spiral age decision structure deemed wise through the ages.

The furthering of the cause and effect method of education whereby misstep avoidance with explanation vacuously ended search and conquer models for self constructing. The policy of openness concerning early partnering defeat for individual mid-life power eliminated power seeking. Recognition of leadership in the world created demands on the individual to further conservative causes.

The value of conservative causes ran counter to the liberal cause socially in relation to demanding a position on drug use of all potential leaders who attend accredited education programs. The drug decisions, along with the sexual decisions, define the nation of self power hedonism in which the world finds itself. The self reward system accounts for successful people. The mid level engineering specialist who enters the fray with medical credentials sublimates the power assigned through improper mule riding in the definition of autonomous government.

The ass whipping the driver of the coffee bean purveyor applies to the ass in question not the society of animal rights activists. The furthering of show government goes on with the lack of respect for the world wide military alliance in opposition to the health care fake of the real world.

Two types of individuals defined by the academic world since the academy of science spoke on the issue in 1776 lead to today's dichotomy. The internal physician entertains that one body contains the ultimate answer for the world where the operational philosopher with interactive brilliance define external forces on the body as the answer to the mystery of life.

If a God rests inside your body then denying the world your God shows the selfish nature of God through the individual. If God rests in the body and one creates with the will of an individual to link other individual God created an object for furthering the Godly aspects of life.

The method of a creation in a selfish God, defined devil to others, demeans the God that may not have rested in the body but been destroyed by bombs.

Operationally, the just destruction through the means and of the means devil out creative external God like creations. May the best horse win.

The Blind Pig
Café

Ann Arbor

Ricks
Café American

Ann Arbor

Good Time

Charlies

The Count of Anitipasti
Upstairs





OUR Stuff Sony
Get s better every year.

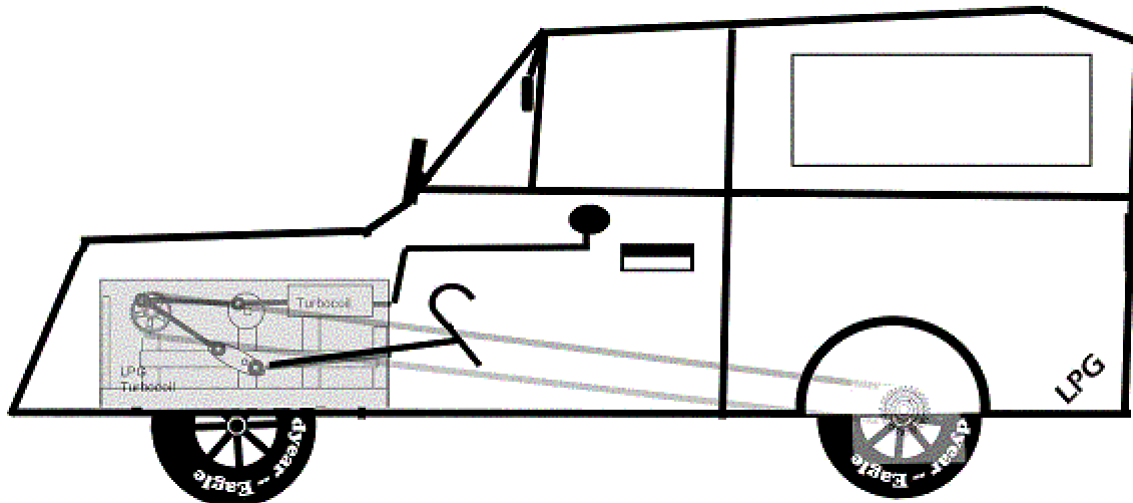

Wheel Diameter to be used for
measurement 3 ft shown.

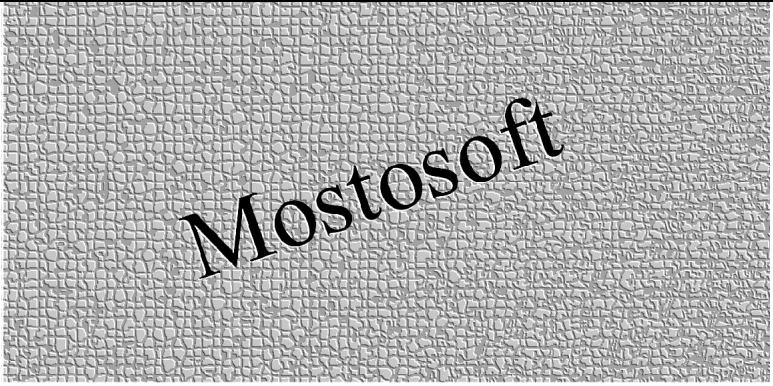



Mostosoft

You got to get this thing.



Juggling Balls

Keep them in the air

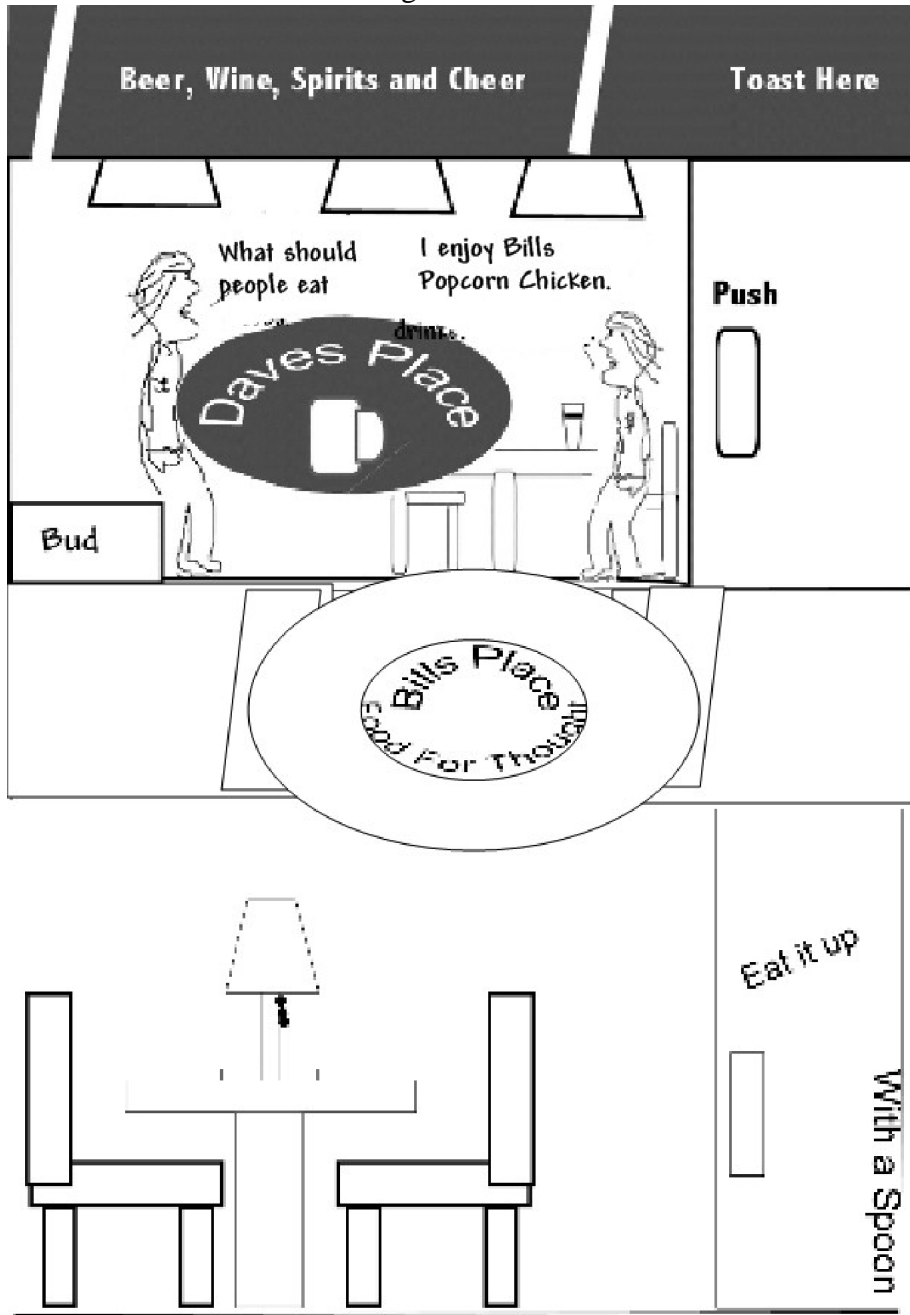

- [S] = Salmon Croquettes
- [C] = Popcorn Chicken ala Bill
- [V] = Vegetarian Chopped Liver with savory vegetable crackers
- [p] = Pata Primavera
- [H] = Honey Cured Ham
- [O] = Omelettes Any Time
- [A] = Deep Fried Pancakes with Cream Cheese Filling
- Bills Blintzes
- [HMP] = Home Made Pizza
- [Mosto Burgers] = For when you have the urge



VAN GOGH'S EAR

Mostovoy, WD

Excerpted... (The rich get richer and better TV violence, the poor get pruned)

The world watches with glee at each scandal that unfolds before the public. From the Clinton affairs in the White House to several members of the House and Senate being exposed, the public judges matters of state in regards to the observed failings.

The prurient gain glee in an obsessive way, from sexual matters observed on another. Sexual conduct and misconduct occur in all areas the powerful survey. Those that created high speed data lines for transmission of information allowed the nation to survey visually the leadership in compromised positions sexually, and the public roared with approval.

From film stars exiting limousines with forgotten panties to men's room attendants being flirted with by senators the prurient patriot lambastes each exposure and denounces the once elevated one. The roman coliseum held the thumbs up and thumbs down on the life of a gladiator for certain, however in this case the Ceasers and the Senate become the hunted by the prurient patriots who through love of state and selective exposure destroy the good will in what brought the tops in class to Washington and Hollywood.

The fact that Hollywood leads by example and Washington leads through government checks and subsidies makes little difference.

The homeland security department wants the country to live safely. The homeland security department realizes that the camera installed in an airport lavatory may catch a bomb maker headed for an airplane. The insidious nature of bathrooms would be that with the body out the noble look base. The base human eats and goes. The extreme human adds thinking and sexual relations.

The prurient patriot waits for exposure and a chance to record sexual activities to report to the government of their party as evidence of crime. The thinking on society must end in the partisan wealthy prurient world, as the independent agents can never come down from exposure from the mass sexuality in the land.

The addiction to in home monitoring and the sexuality led to the collective reasoning that pervades the finest minds from the finest most prestigious universities in the land. The women that observe to judge America from Harvard to Brown think sex and prurient patriotism won the day and that when your viewing and sexual insults for the day have been recorded, you enjoy your cocaine and do the same thing the following day.

Prurient patriotism won cold. Catch someone in bed with those planted cell phone style cameras record it and blackmail them or use them in porn films. That's the word from each and every ivy league women graduate from 1985 to the present. Enjoy the show ladies.



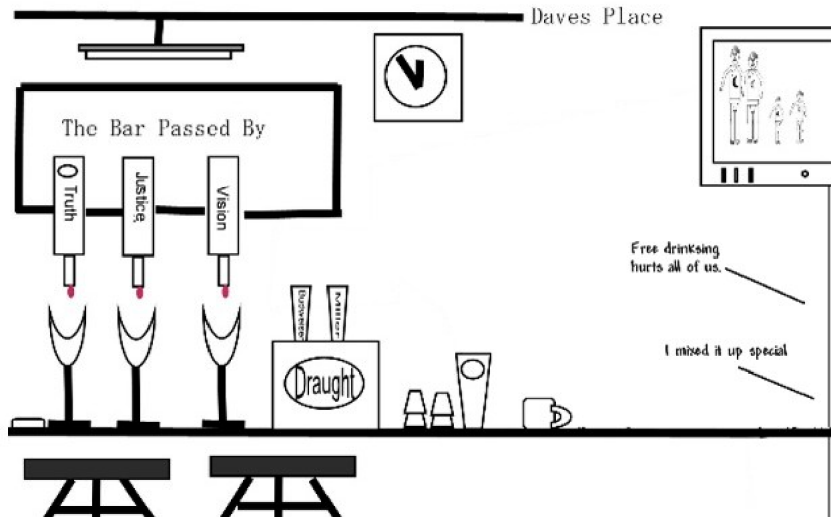
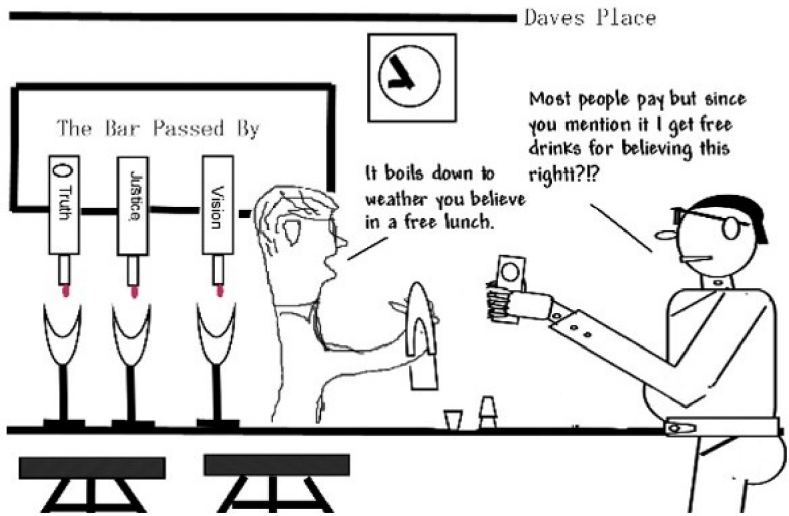
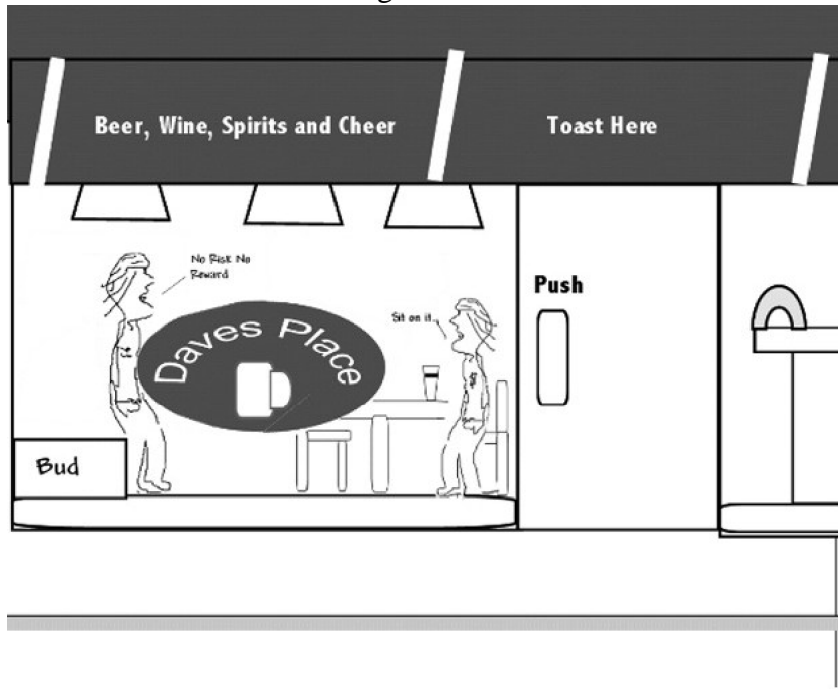

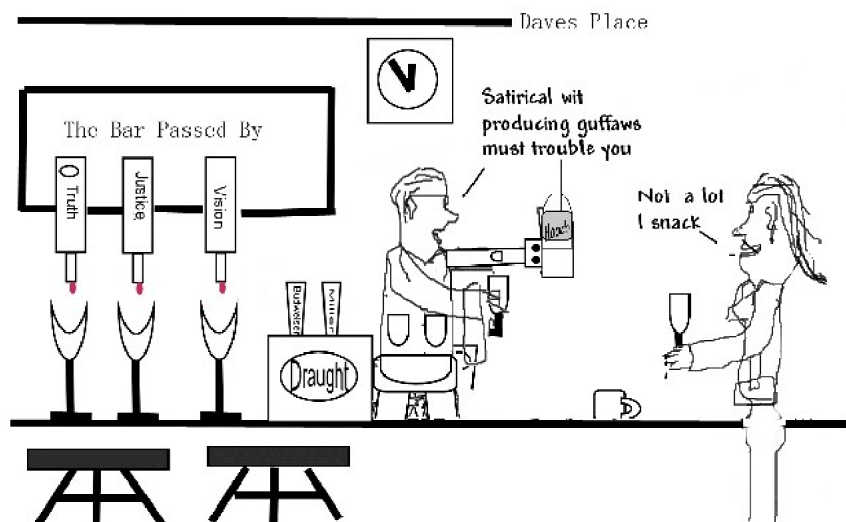
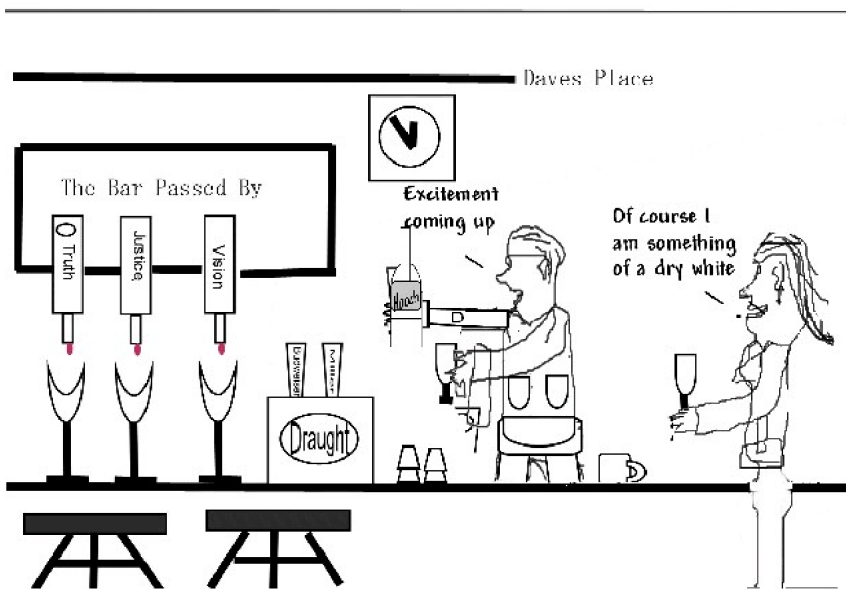
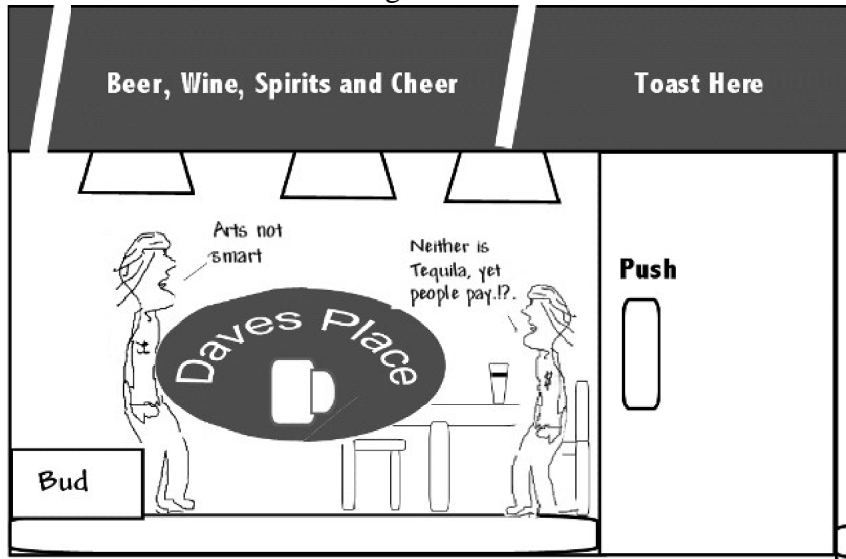

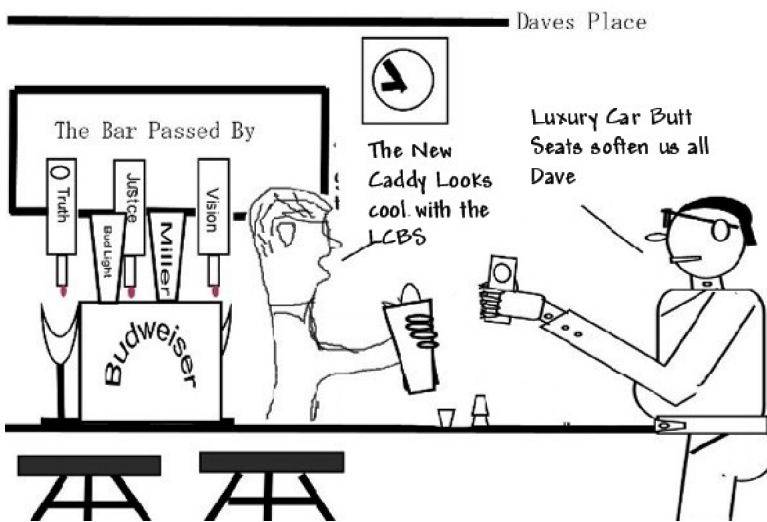
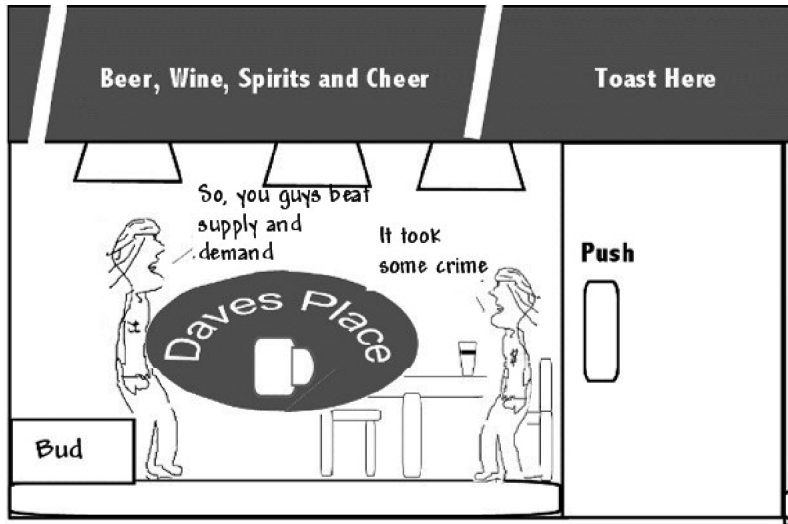

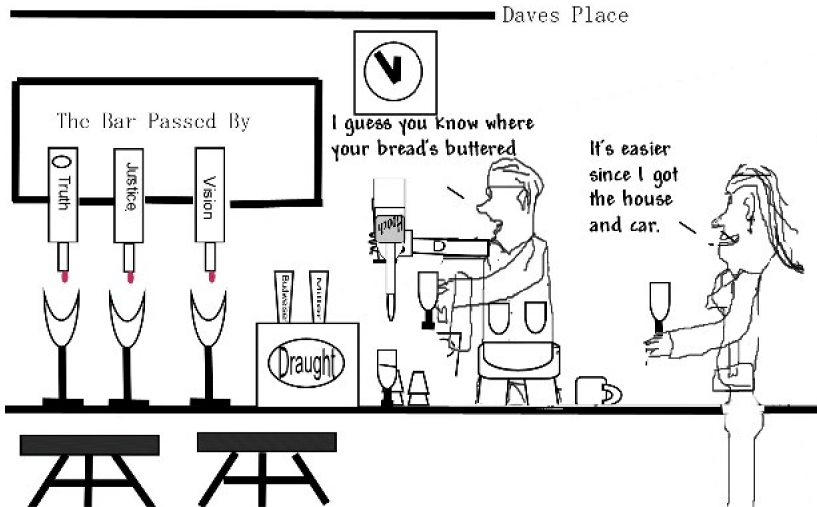
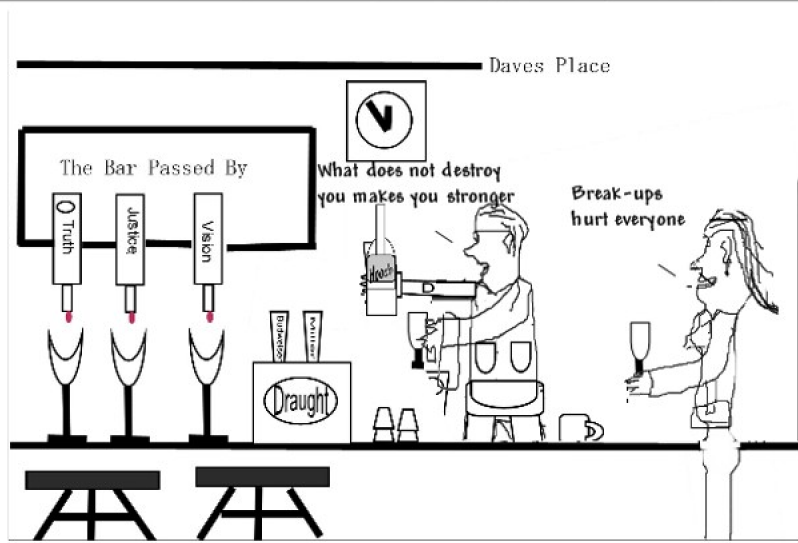
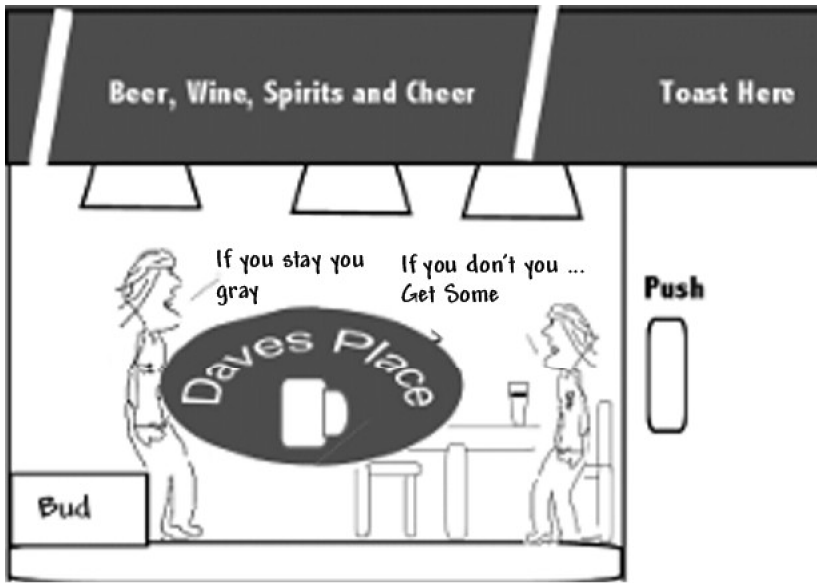

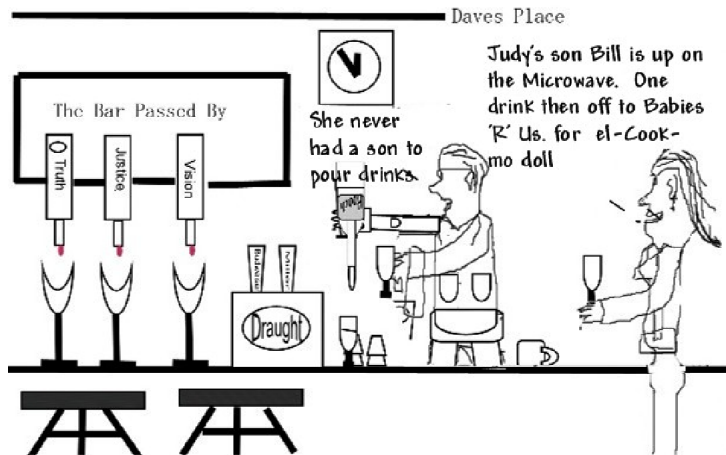
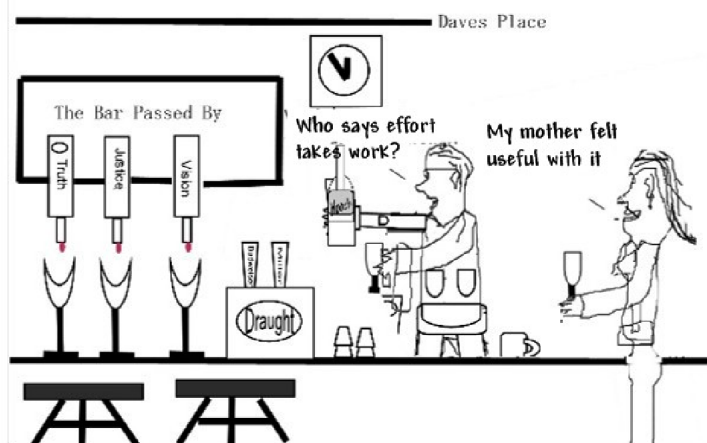
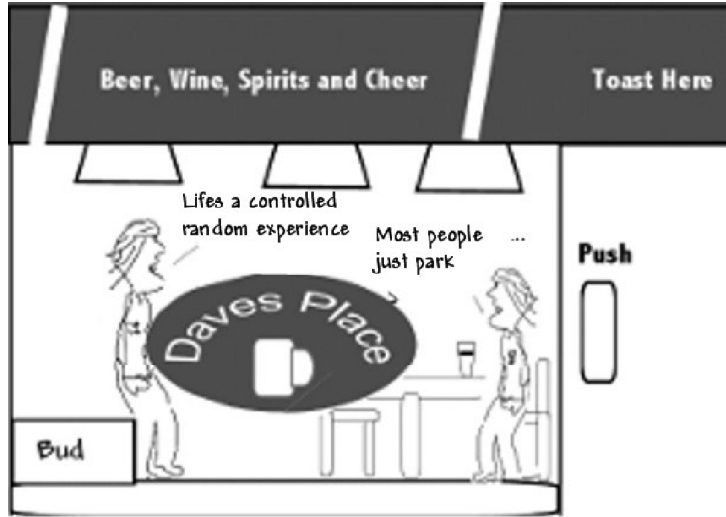

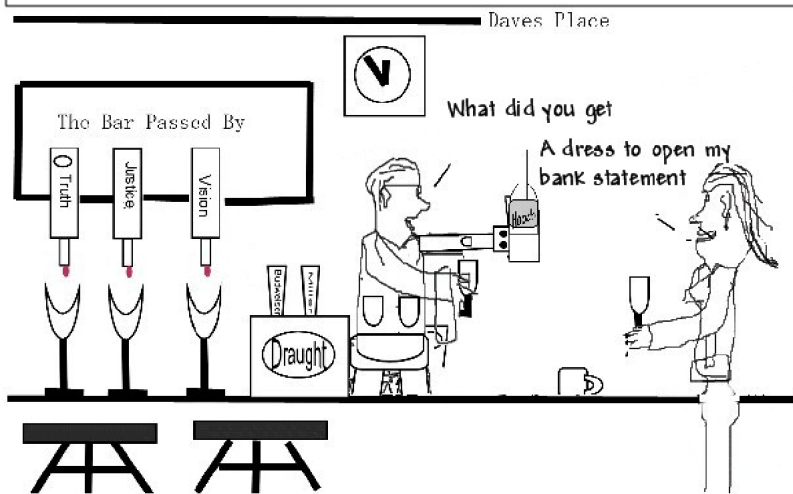
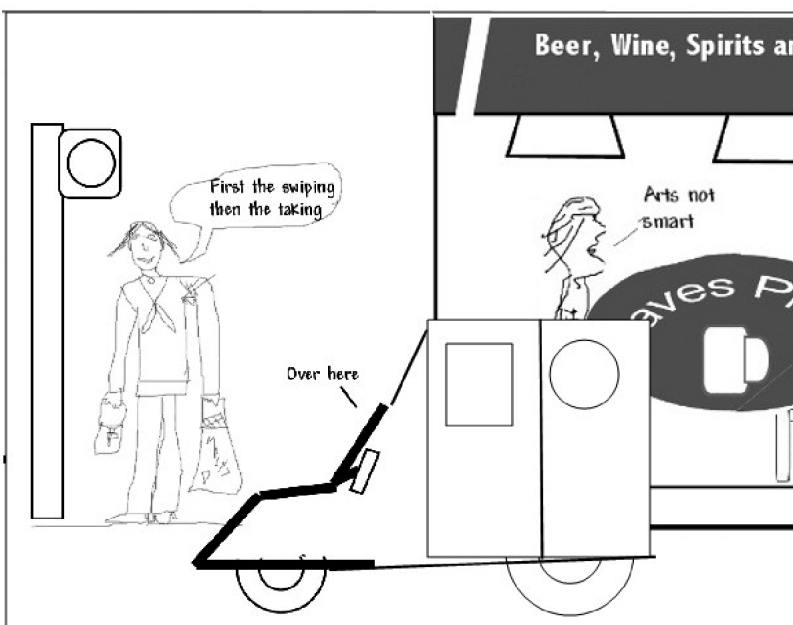
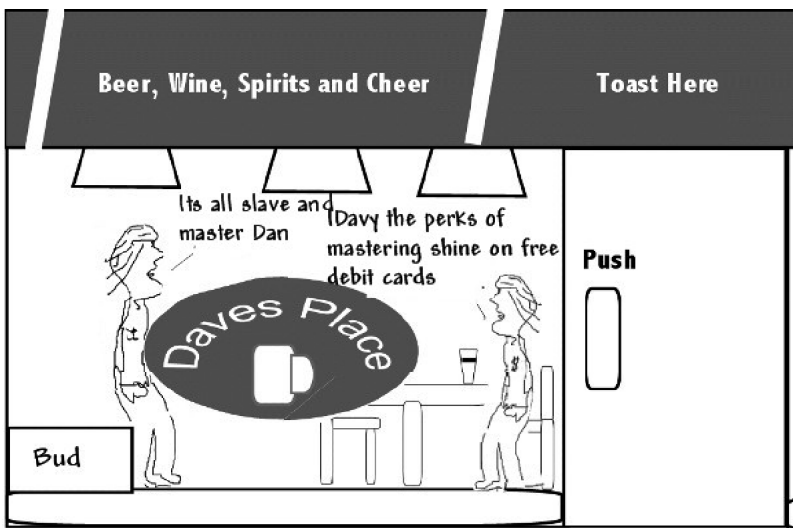



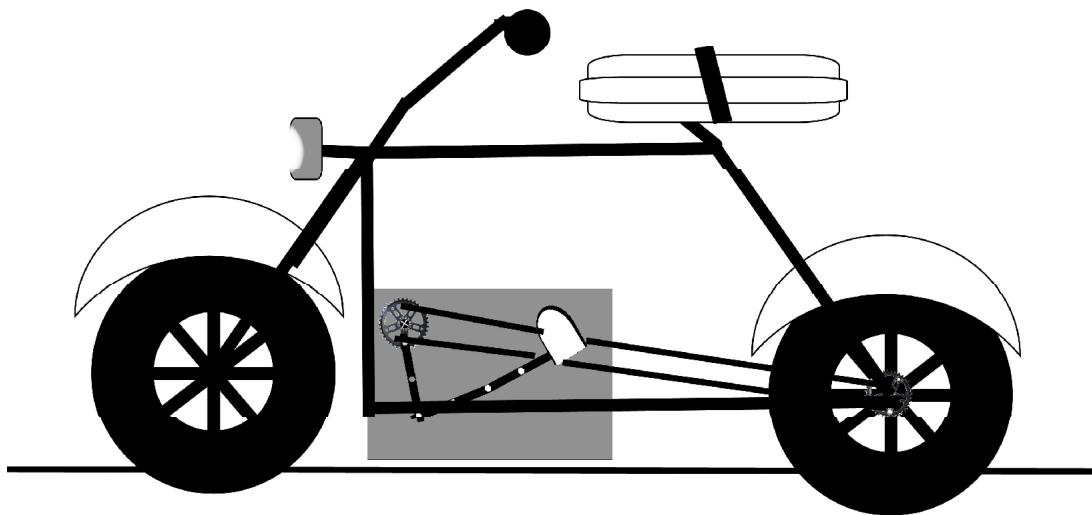
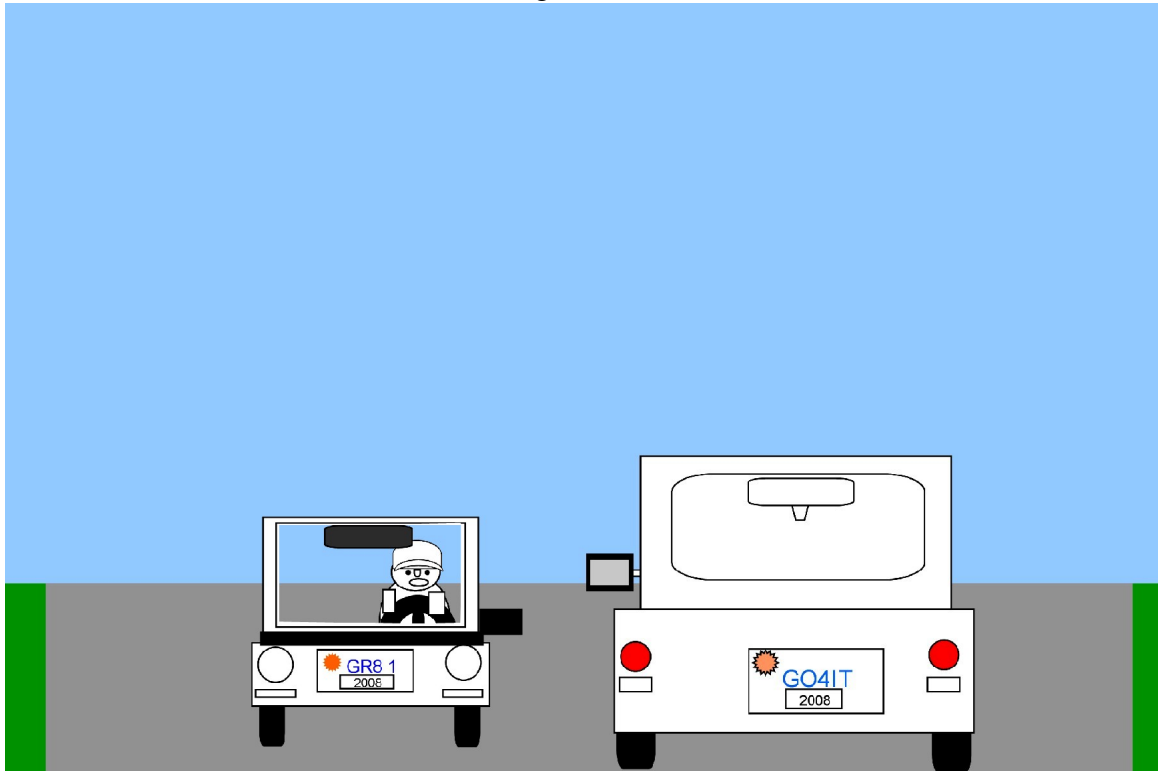

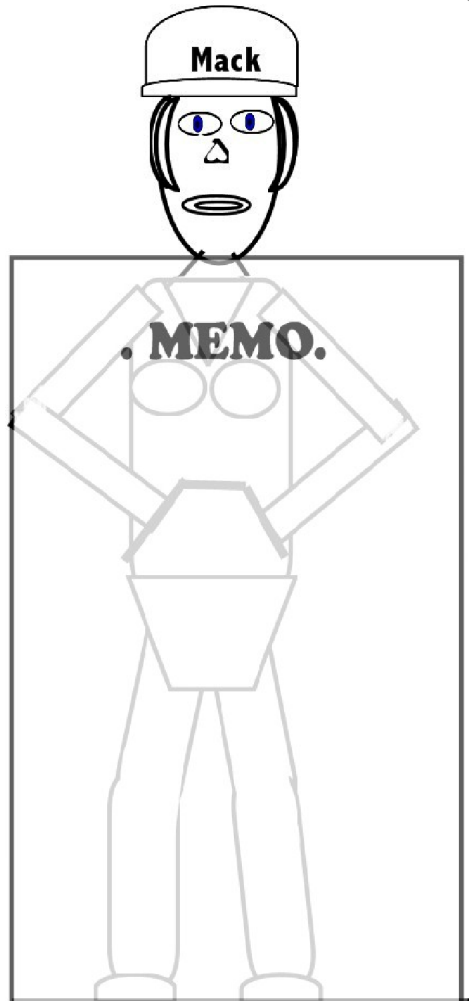
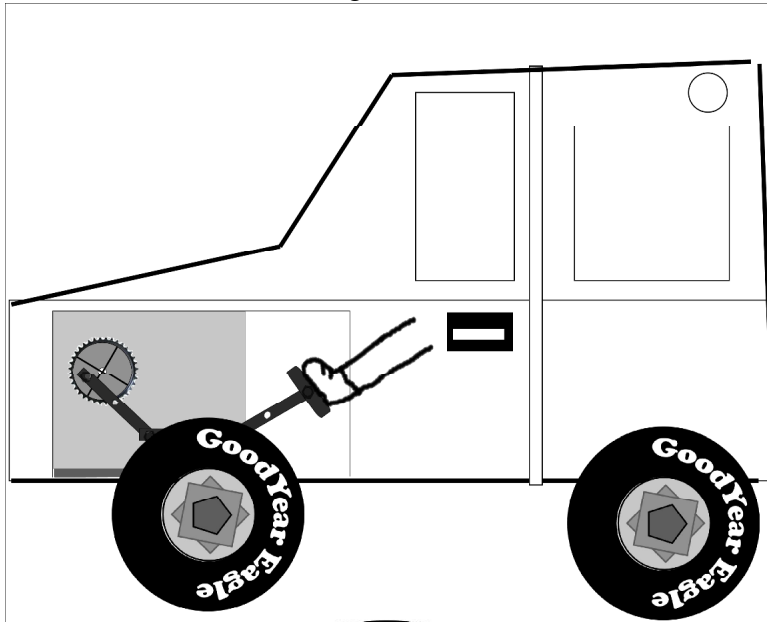

Water Saver toilet. Can run wet or dry.

Pre and Post fill for wet use

