

\$4.95 USD

Mostosoft Magazine

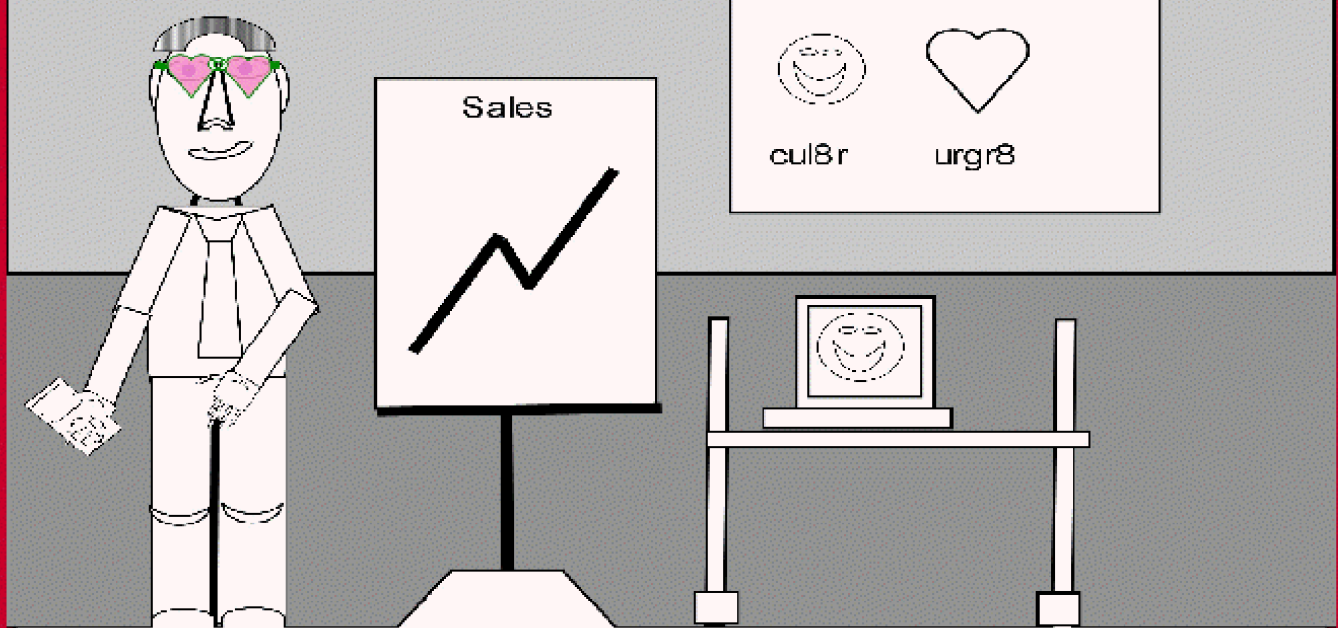

Skinny Post Cycling Arrives

Texting....LO L L8 D8 xaspr8ed1

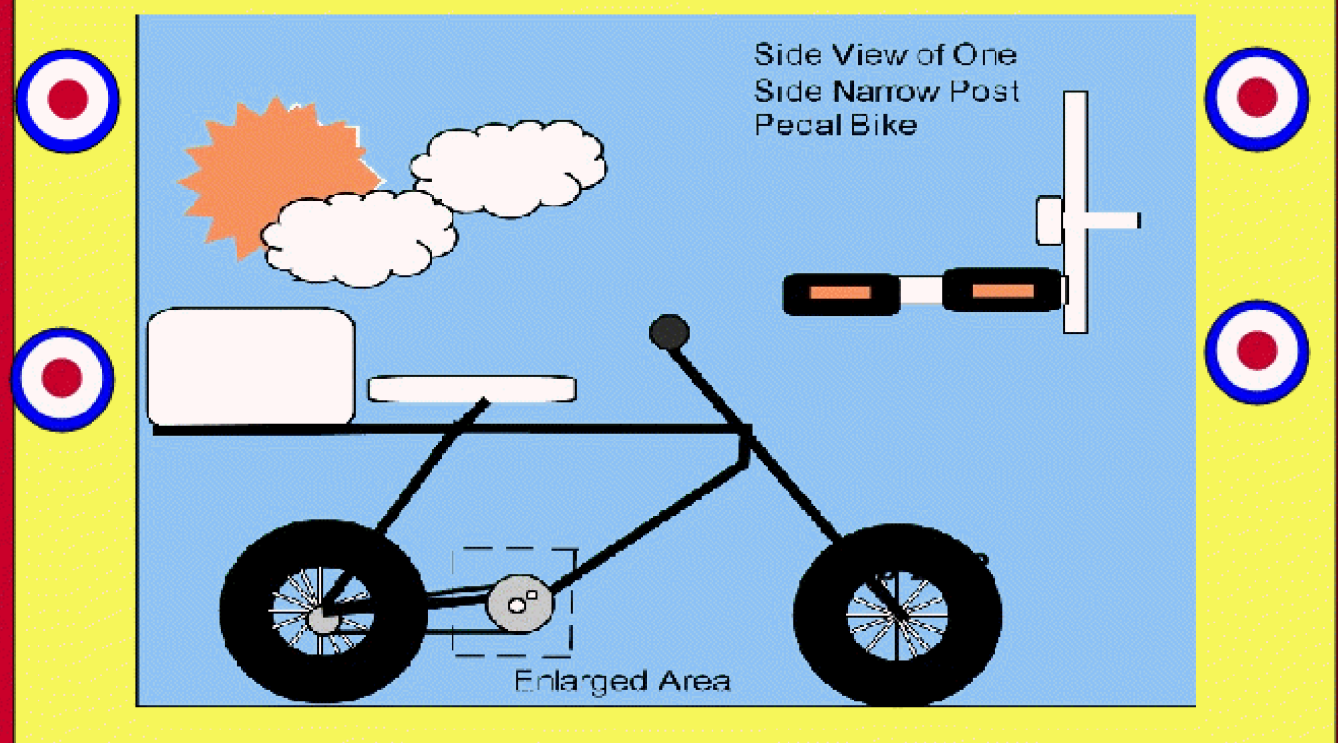

Side View of One Side Narrow Post Pedal Bike

Enlarged Area

The Official News Magazine of www.mostosoft.com



- *New Fiction and Video*
- *Daves Place Jokes*

Feb 2008

**VAN GOGH'S
EAR**

Mostovoy, WD

Excerpted text

The land welcomes those that work with her and her people on the continent. Dedication to linking the generations through the symbols of government continues. Recently (commentary) the noteworthy hear the ill wind that the old men knew very minute amounts about reality and that new thinking puts a Tom Jefferson and Ben Franklin in their places with the thinking of a Mr. Snipes and a Ms. Latifah.

The states that want to win the market share economically often preach the casual nature of the United States belying the fact that the rights to life, liberty and the pursuit of happiness must be defended as constitutional issues, not in spite of them;.

Definitions:

Leftist(n) – One who believes in the collective model of equality. One who believes in collective ownership of the means of production and all property.

Conservative (n) – The conservative believes in the individual's ability to control ones destiny in the public and private sector.

Centrist (n) – The centrist believes in interpretive thinking to determine public good issues as well as private property issues.

Dictator (n) – The dictator decides on the good of the nation.

Fascism (n) – A form of government where orders from the elite dominate the free will of the population.

Communism(n) – A form of government which believes in equality amongst all citizens called comrades. The decisions of the state involve decisions for all comrades. Leaving the communist state and traveling, take part on an approval only basis.

Democracy (n) – A form of government where the population elects officials to enforce contracts between citizens and the state.

Freedom (n) – An individuals' right to self-determination on issues that do not supersede the rights of others.

Opportunity (n) – A chance to win with the gifts God bestowed upon a person without the determination by birth order and bribery.

Rights (n) – The social gift of confidence to convey ones manner befitting the standing of a place with the self without regards to social and personal power and strength demeaning normal operation of an individuals life.

Oppression (n) – The denial of human rights, often through fascist methods.

Government(n) – The means of which social contracts gain enforcement

<p>The Blind Pig Café</p> <p>Ann Arbor</p>	<p>Ricks Café American</p> <p>Ann Arbor</p>	<p>Good Time Charlies</p> <p>The Count of Anitipasti Upstairs</p>
--	---	---



OUR Stuff Sony
Get s bett er every year.

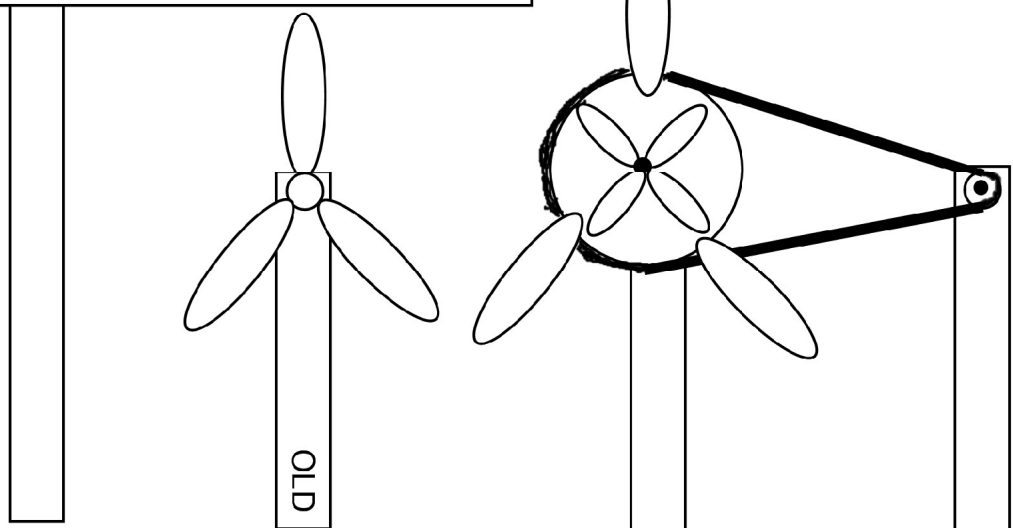

GEARED
WINDMILL FARM

A small icon of a windmill with a square body and a pointed roof, positioned between the words "GEARED" and "WINDMILL".

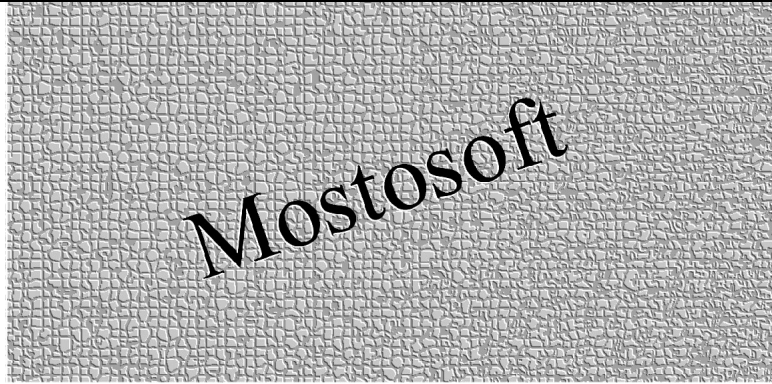
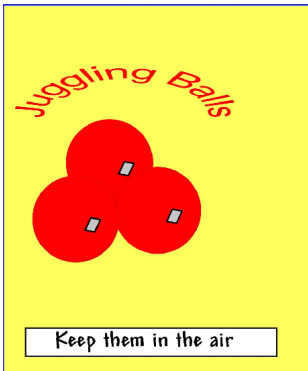

You got to get this thing. We have great opportunities with modern technology to bring life where tumbleweeds once roamed. Both Atlantic and Pacific coast cities have been choked with the Babylon syndrome. The tower of Babble stood in Babylon modern Iraq in biblical times. Each person in the tower spoke a different tongue believing his sound traveled right to God from the high point. Many believe the world trade center was the modern tower of Babble. (ed. Babel)

Three areas targeted for growth here include the triangle Dallas-Houston-San Antonio Atlanta-Charleston-Raleigh Durham and Phoenix-Tucson-Nogales

These areas have a remarkable similarity of individuals who believe technology can support life on what was once a brutally hot and arid environment. With modern methods life not only goes on it thrives without the philosophical approach of whose voice rings truer to God. As I have heard it the similar folks just believe it of themselves.

The coasts in newly recognizing the capitals plan for development need to send some college students and graduates to finish at Emory, U-T Austin and the University of Arizona from any East Coast University, U-C Program or Stanford. Regional efforts need to be made in the geological sciences, materials, water reclamation, organic chemistry, biology and the arts.

Recruitment of realist painters and artists in small numbers of about one hundred per city in an art institute setting adds some culture to elevate those that live inertly much of the time. Innervating while level the cotton and oil business, the nation supports the business of producing well citizens.

Let national efforts continue to educate from the good east and west and let terra forming and cultural shaping take place well.

Could I get you to say You Betcha.

**VAN GOGH'S
EAR****Mostovoy, WD**

Excerpted... (The rich get richer and better TV violence, the poor get pruned)

Many individuals possess memory, only until sexual release. Other individuals remember well until the next binge drinking episode and drug party.

The world of women seemed to divide between the women that could store and believe themselves to be in a store of knowledge beyond a 28 day cycle. Many took to calendars and computer reminders to assist them in staying the course towards a best life.

The getting in touch with ones personal feelings each month provides a great insight into the care each women gives to her area of influence.

The computer sphere of influence spreads globally with no real focus on what healthcare might mean to the male population reeling from release with the concubines and Swedish and Dutch prostitutes.

Some men made in sire father before health care death. Items on a schedule might read love of country and patriotism, yet the republic that finds itself anew every 28 day owns no tradition other then the new tradition of kill and release sexually.

The orders given state take no prisoners in the male world. The woman revolt went over the top.

The fact that men love women makes sense. The fact that women love women makes sense.

Men held a great feeling of belongingness that with open clubs to video and membership, the belongingness became replaced by the home love that never really shone brightly for most men.

Since no men belong to anything without love they do not belong in there life here. The navy and the world military bases explode to find a membership in a club that for even a shining moment allows something low to be seen in a mans high mind.

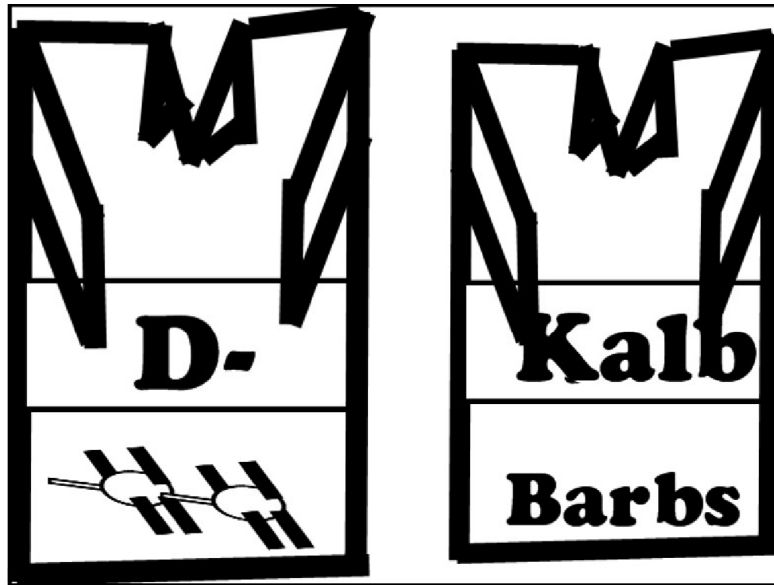

Printing out a snack cabinet sign enhances at home food.
For bonus points charge yourself for refill orders.

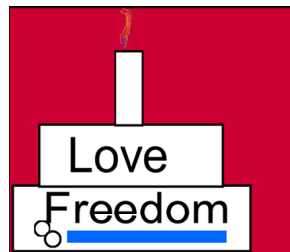



(Size of a stick of gum)

This memory stick holds 4000 MB of information.
That's one hundred of those 40MB PC's in 1990. (4MB ~\$89.00 depending on manufacturer)



Hard Drives upped in size to 500GB going for \$249





Upon the rocky shore.

**Let Freedom reign oer gloried flight
The seabird sands the Frolickers nights fight**

**The daily grind mixes dust
To show the world that life does trust**

**The Swallows Gale Force Winds
Leave Free Our Sins**

**Others dance and twist sublime
The earth below finds the time**

**To ebb and flow another day
Each and every to her gray**

**Five fingers on each hand
To return from beach to sand**

**Every night the glimmer moon
Lifes short journey ends to soon**

Author WDM

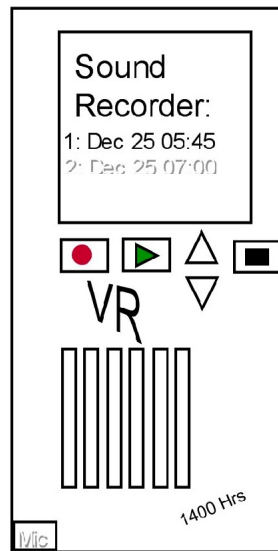

Most people turn them on for all dates at home.



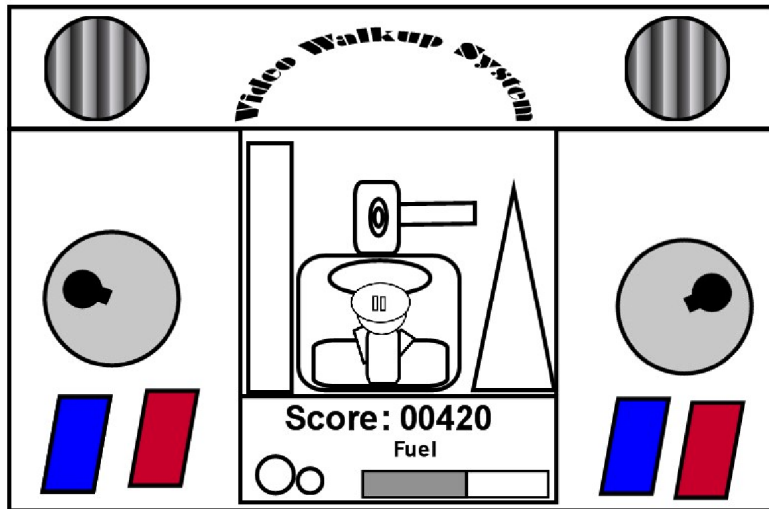
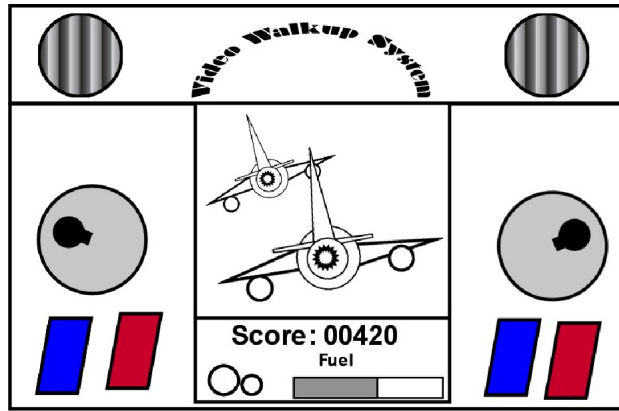

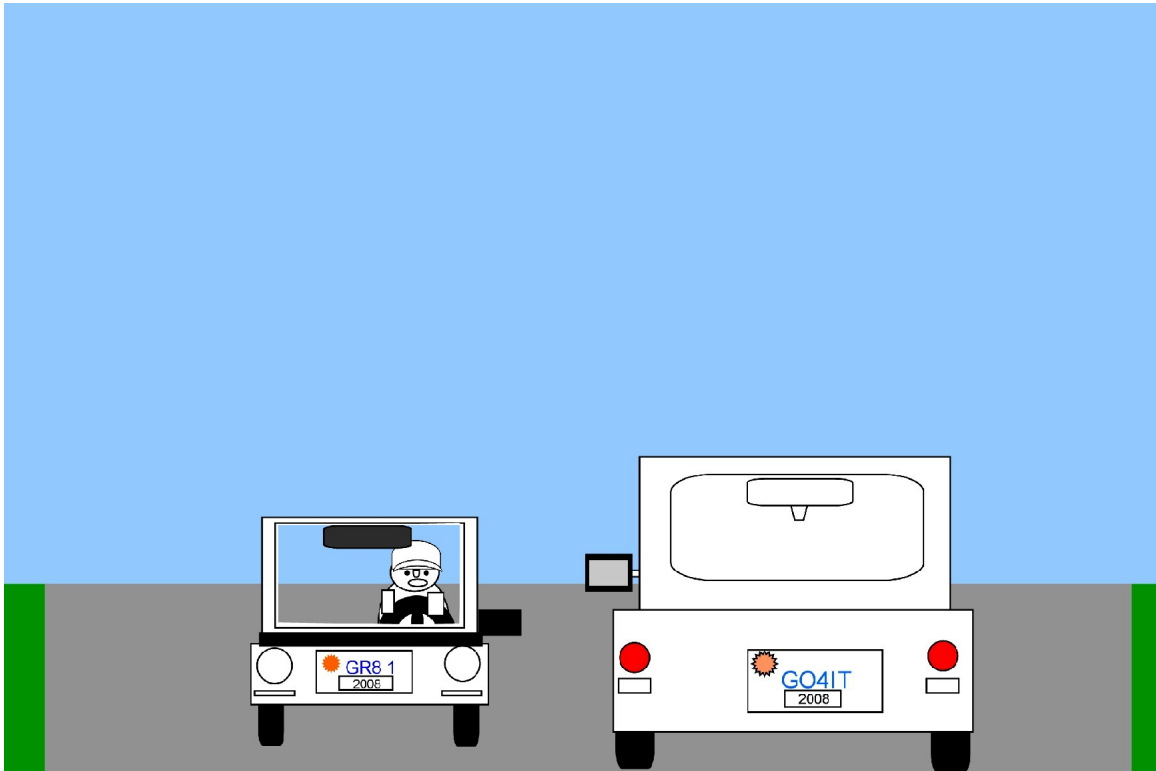
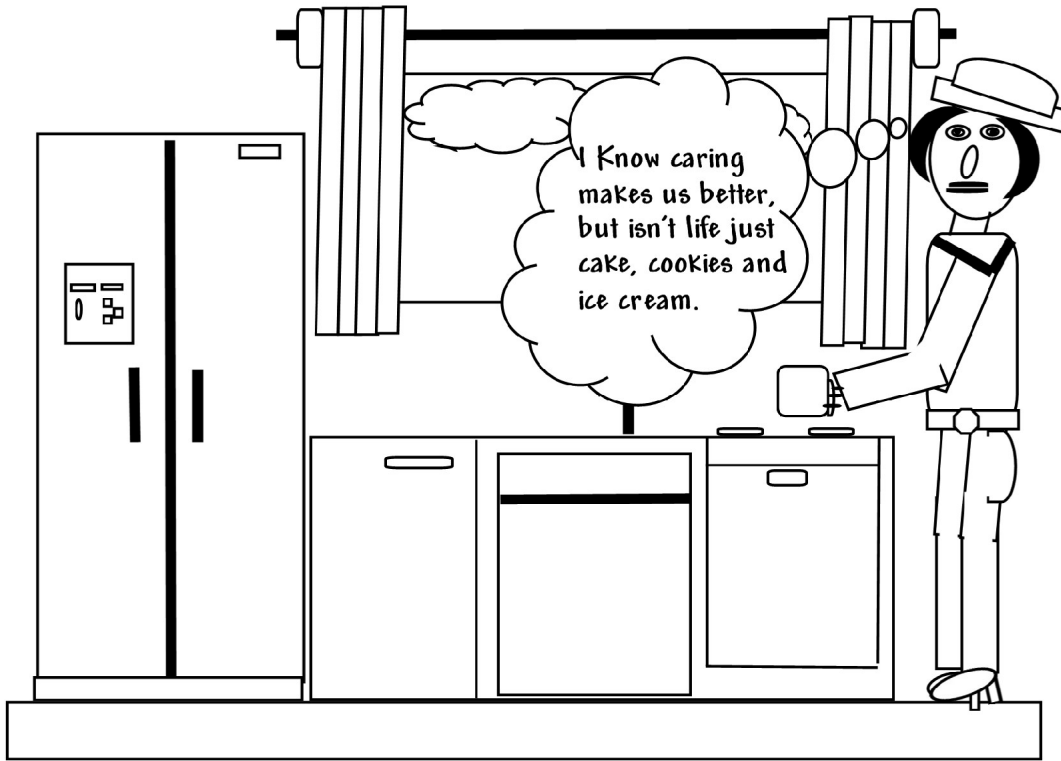

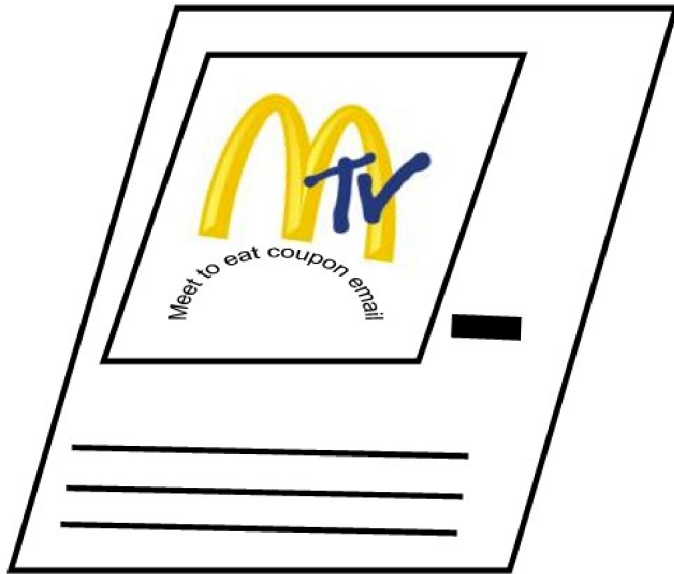
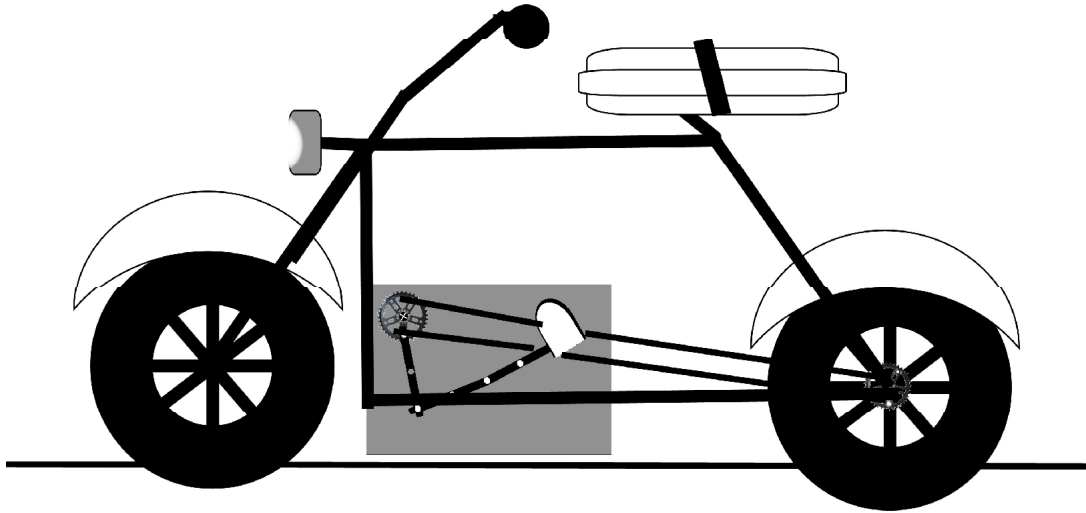

McEmail

Send a coupon with a 255 character message. Each McEmail system individually owned and operated

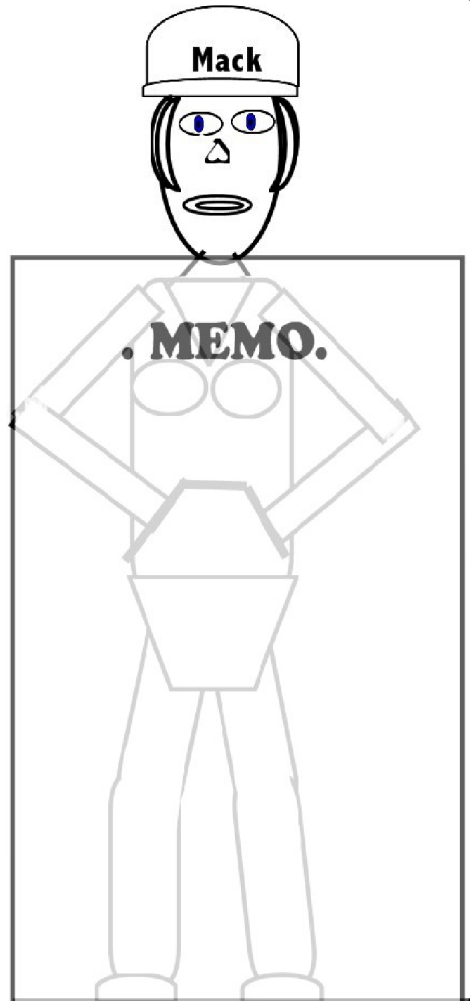
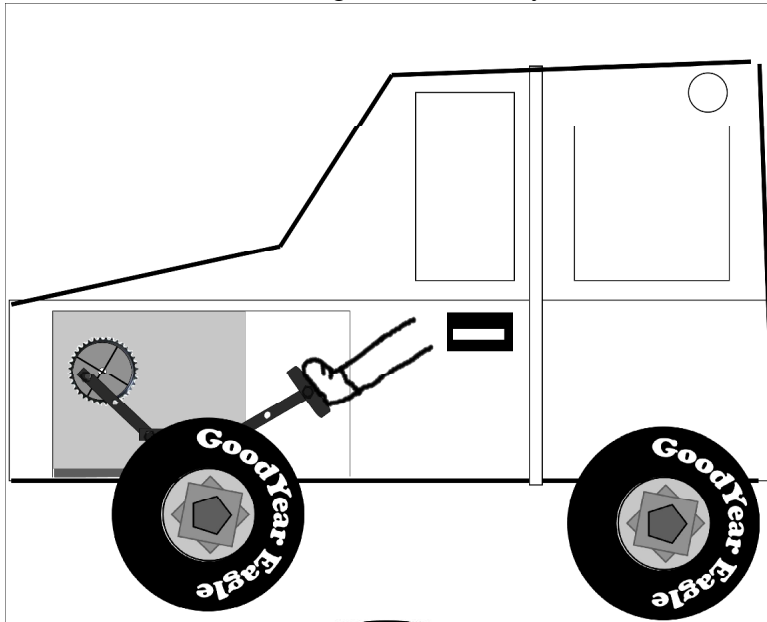

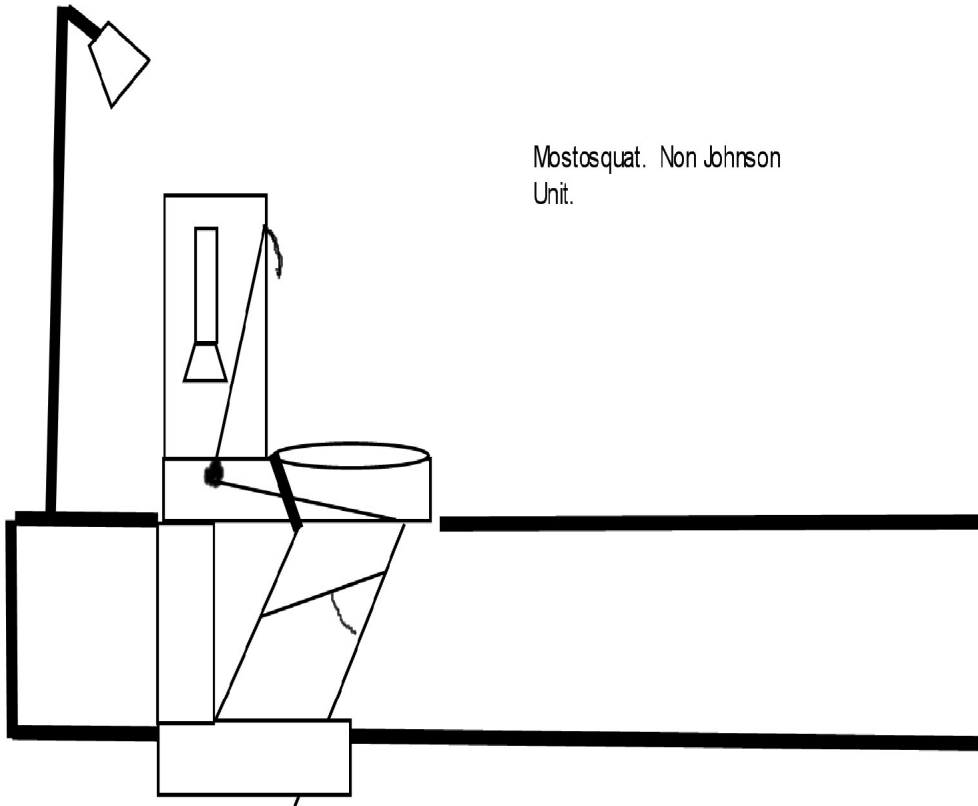

Mostosquat. Non Johnson
Unit.

The back side scrape is the key to the new style toilet. Pre-Fill to see waste as normal. On completion use the sprayer. Auto spraying defeats the purpose. Women said life was to easy and had nothing to complain about. So I have given them the have you prefilled the bowl dear.