

\$4.95 USD

# Mostosoft Magazine

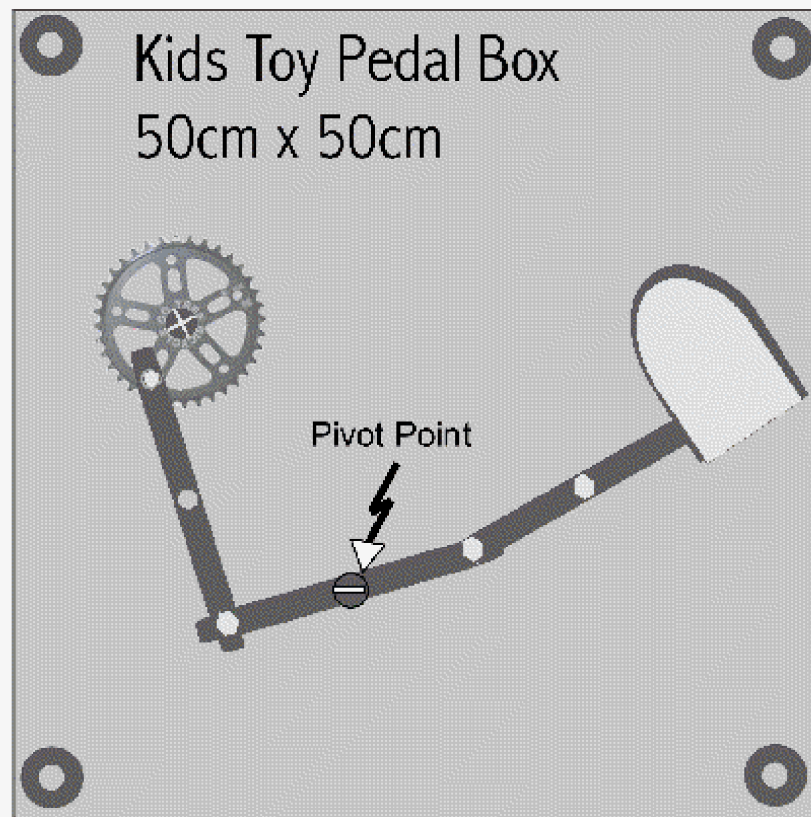

REAL STUFF ALREADY 2008

Close and Play Apple  
Air Music System

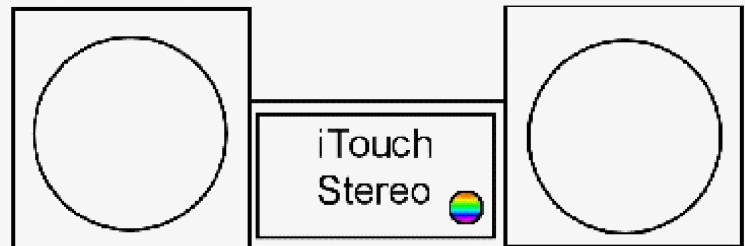
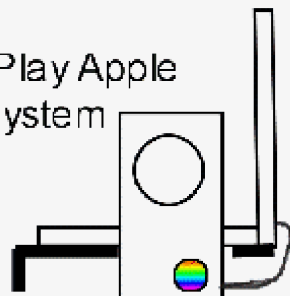

The official news magazine for [www.mostosoft.com](http://www.mostosoft.com).



- *New Fiction and Video*
- *Daves Place Jokes*

Jan 2008



# VAN GOGH'S EAR

Mostovoy, WD

Excerpted text

How one votes depends on many factors including your wealth and your crest. The Republican Party supports the economy of the wealthy, which by virtue of great corporations pay respectful workers in a trickle down manner. The aim of the Republican leadership through eased restrictions leads to a greater society with opportunity.

Republicans tend to dress well and act in accordance with a persons standing in society. The candor and expectations placed on the Republican can be exacting. Republicans do what they are told and expect the same from others.

Republicans know where commerce takes place, who is involved and how to shake a hand. The system works because of the Republican effort of respect.

The Democratic Party supports rights for people who never seemed welcome in Republican clothes including respectful women, laborers, union members and minorities. The Democratic Party believes in giving people a fighting chance. The Republican Party believes through religious demeanor the chance should be left to others.

The Republic stands at a crossroads in many ways. Many travel from the university to take on new eagle challenges, expecting there old homes to remain the same. As one who had to move back to the "old board" (a reference to a monopoly board of roads) I see decay in infrastructure, thought and respect for tradition.

Those new boards look good to us back in New York, Chicago, Cleveland and St. Louis with the knowledge that the wonderful developments carry around an old image in their minds eye of these once great wonders.

Those that grow cold to the mood based comments here miss that the electorate and the fighting chance people have grown mobile and may ask for something of your life in return.

The Blind Pig  
Café

Ann Arbor

Ricks  
Café American

Ann Arbor

Good Time

Charlies

The Count of Anitipasti  
Upstairs





OUR Stuff      Sony  
Get s better every year.

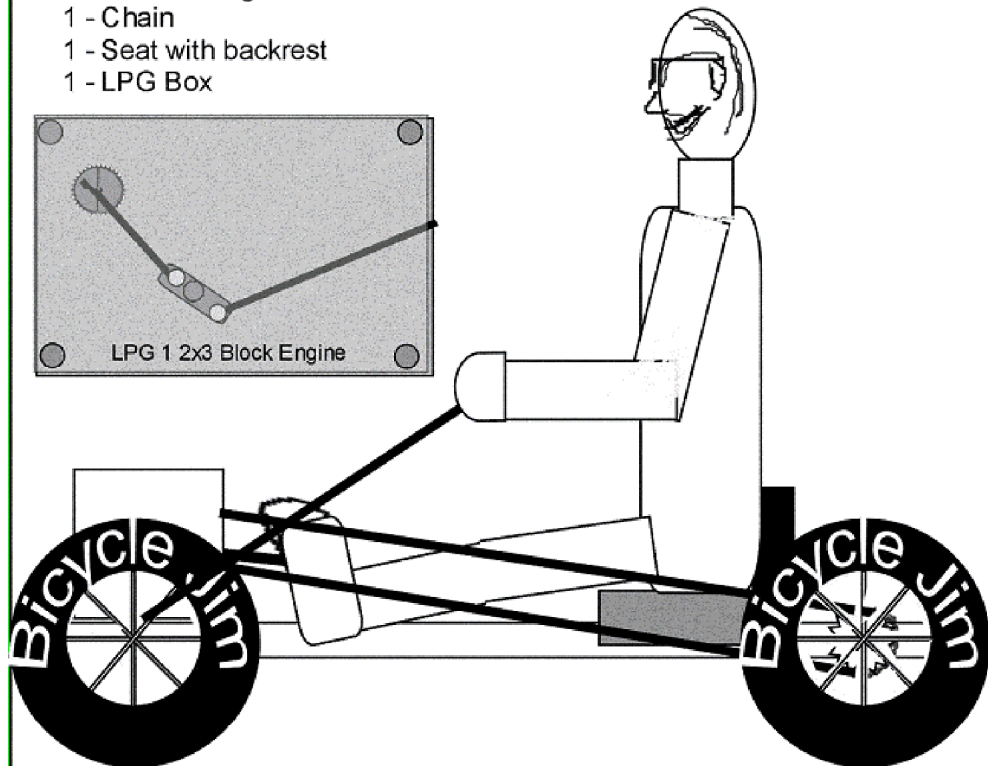

## 6 foot LPG ride

- 2- 6 foot rods fiberglass wood
- 4 - Wheels
- 1 - Slot steering rod
- 1 - Chain
- 1 - Seat with backrest
- 1 - LPG Box

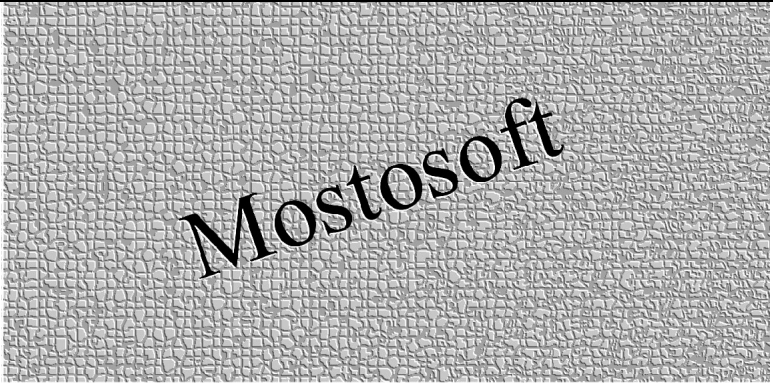



Mostosoft

You got to get this thing.



Juggling Balls

Keep them in the air

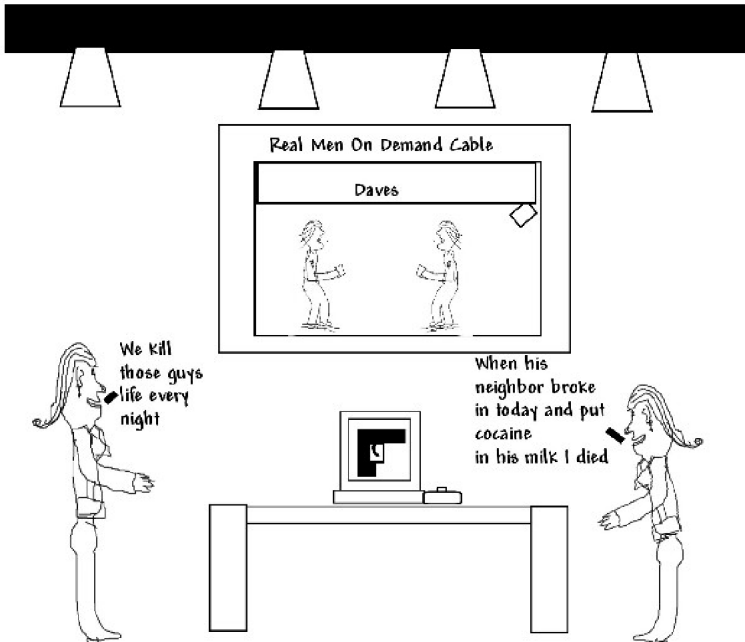
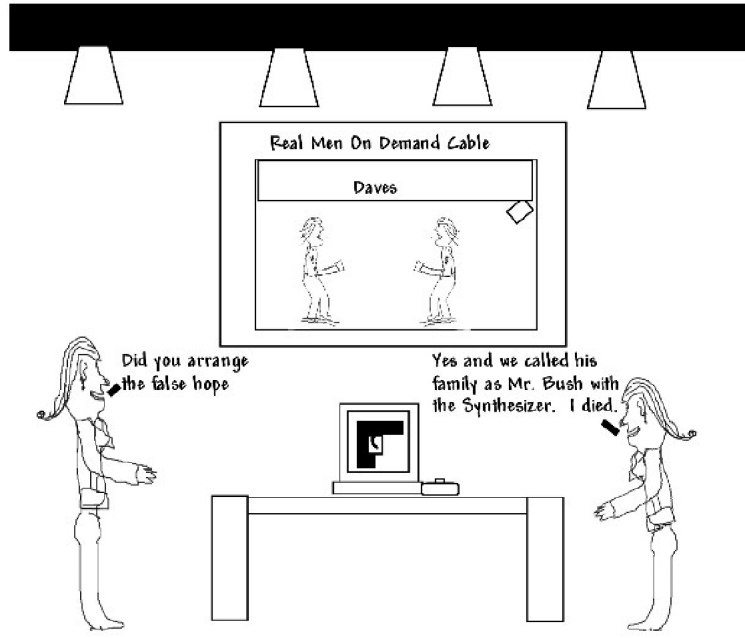
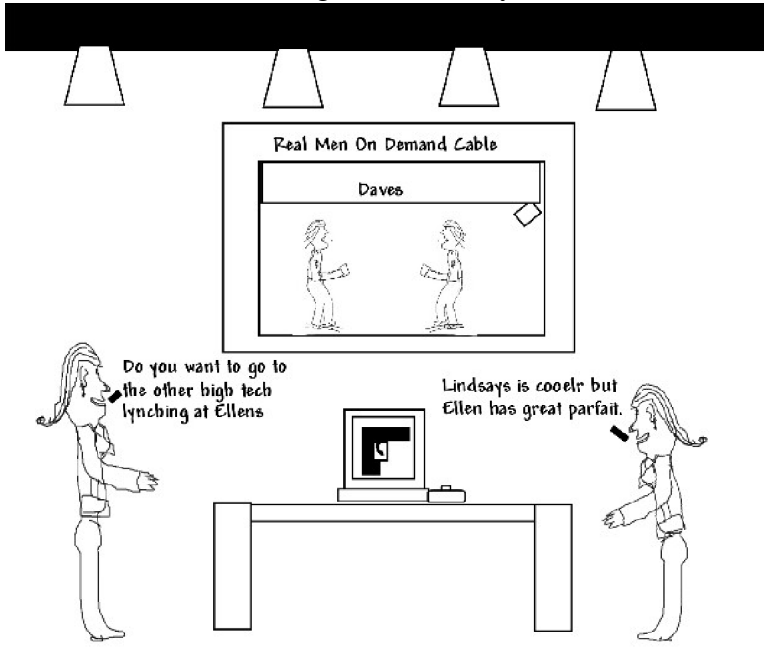

# VAN GOGH'S EAR

## Mostovoy, WD

Excerpted... (The rich get richer and better TV violence, the poor get pruned)

Everyone knows elections reveal the popularity of a candidate. Each candidate takes a pool of money and spends to convince the public of their popularity. The question of what to buy remains the candidates' choice. If it took one dollar for one vote then 56 million passes of a one dollar bill just about does it. The candidates showed up in droves for Bush in 2004 not for any great love for the big Texan but because they received large cash payments as the big rancher, big farmer or big software vendor in town.

Films were made of these big bosses in town and the town went with the big guys in town. In America the super rich enjoy vying for public power more than any other nation on earth. The ability to control the agents of homeland security makes a super prize. In an era where warrants need not be issued to investigate telephone and computer transactions, whomever controls the top ring in Washington controls the banking and commercial lives of the American public. Many lives smeared in good faith in Washington carry the banner of freedom.

Tom Daschle the former Democratic leader of the United States Senate sent this reporter an email detailing the smear against him. Hillary Clinton speaks openly in debate about having to deal with "high negatives" due to intrusive behavior on her personal life.

These Democrats put forth patriotic effort and the pilloried alternative shows strength through the muck raked world.

Yesterday, I read about warrant less searches and a young girl age 10 needed an explanation as to why people "from the government" should not have open access to your business dealings. I enquired as to whether any boy in school had given her trouble and she said she did not like Seth. So I explained Seth's family was richer than hers and that upon completion of her projects he would go in to her house without her knowledge, write his name on the paper and project and turn it in with a grand smile on his face.

Suddenly she wasn't so sure people should take part in these illicit behaviors for the betterment of neither. Try hard and make some decisions in an enlightened self interested way.

Everyone on the take suggests that personal payments show self interest until they need a service from the government. Together Everyone Achieves More (TEAM). United We Stand. God Bless America.



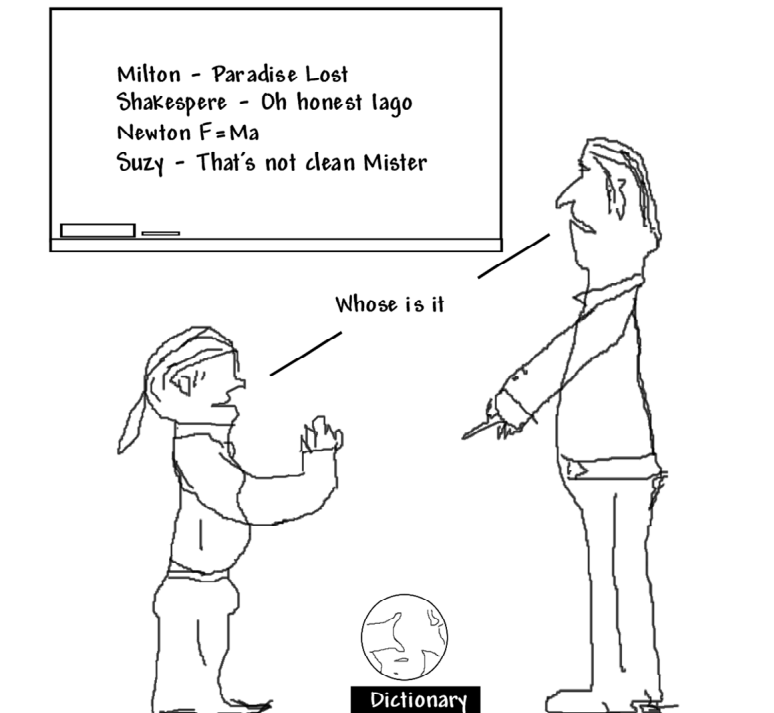
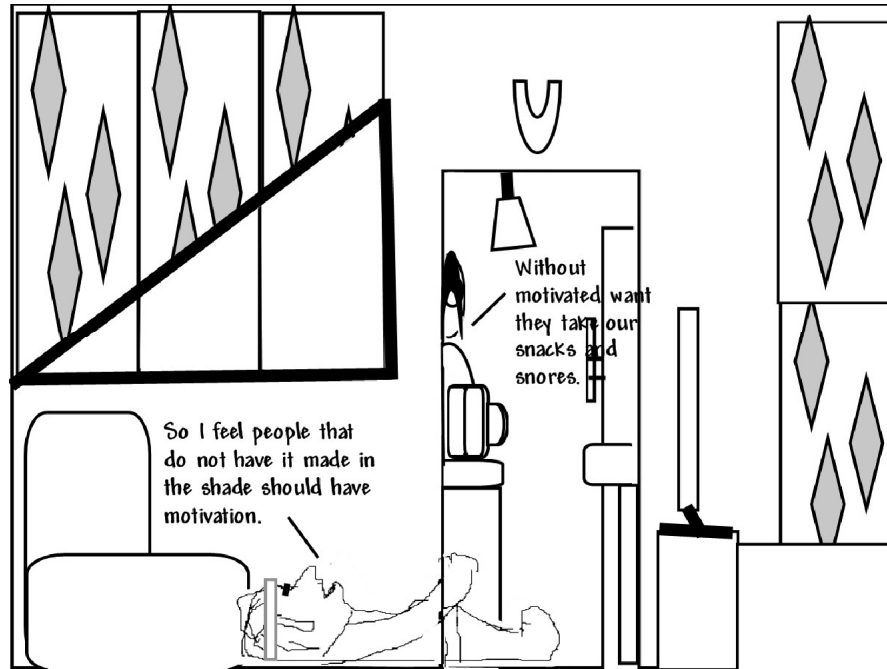

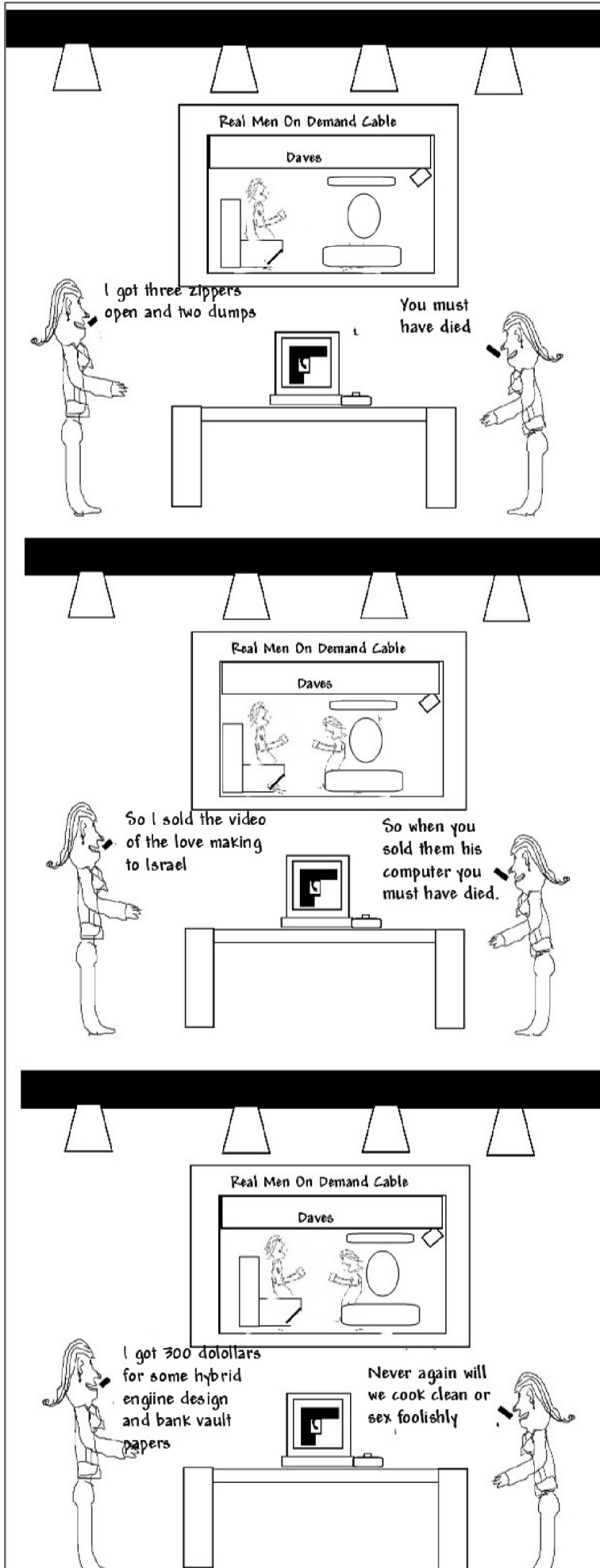

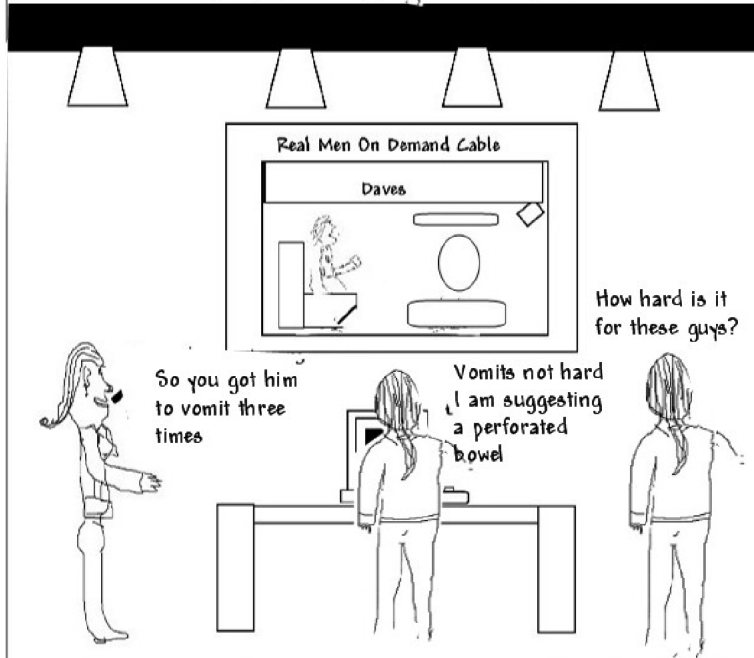
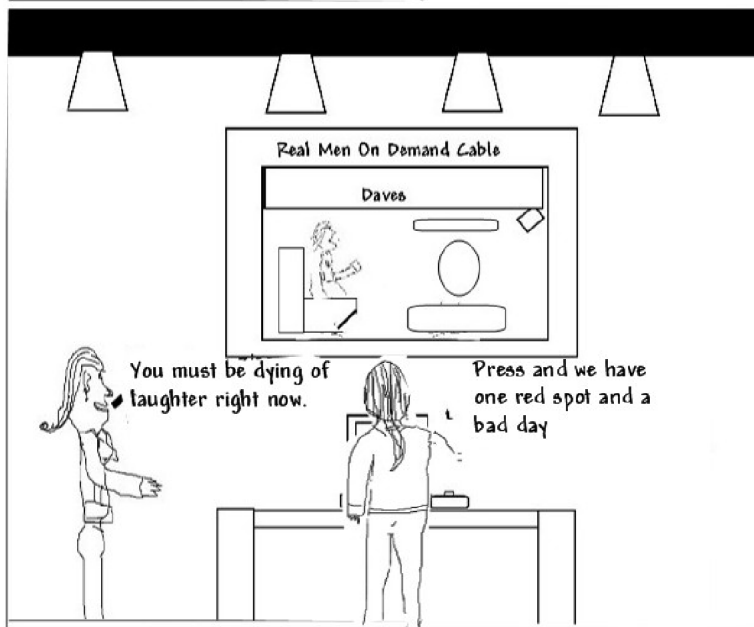
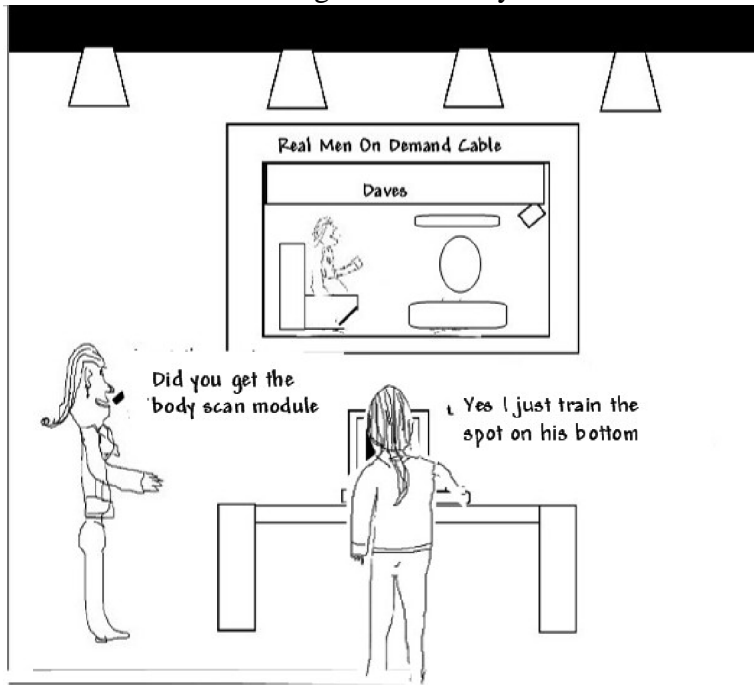

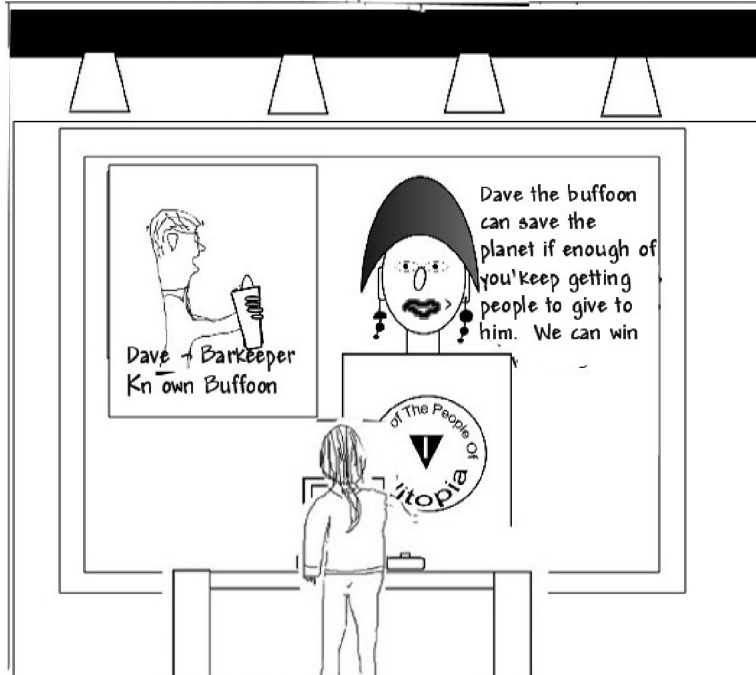
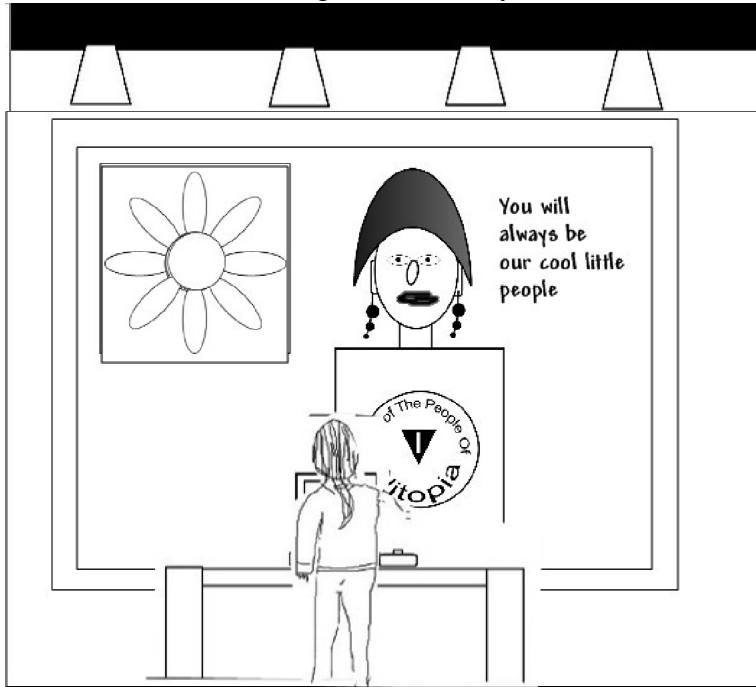

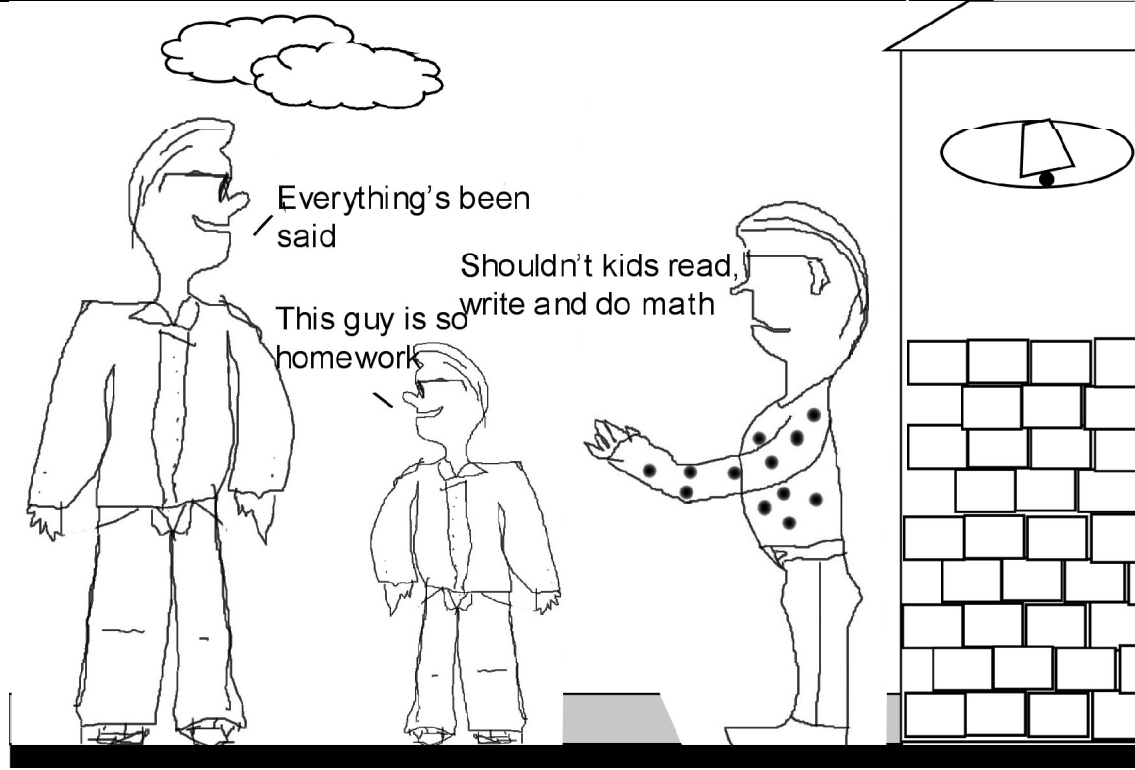

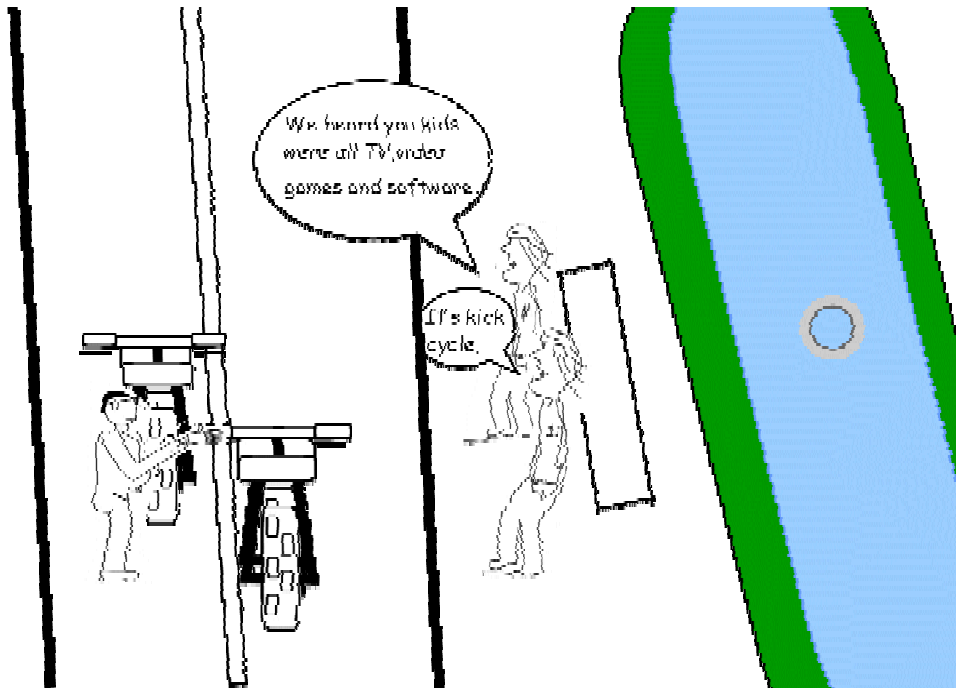

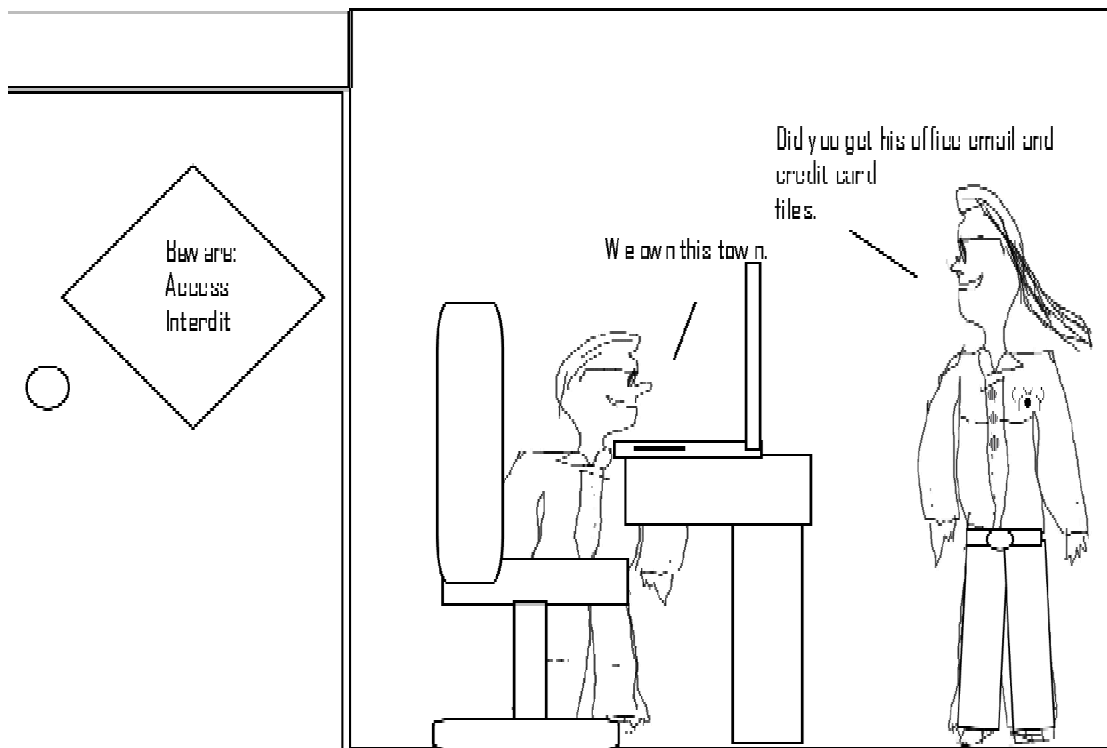
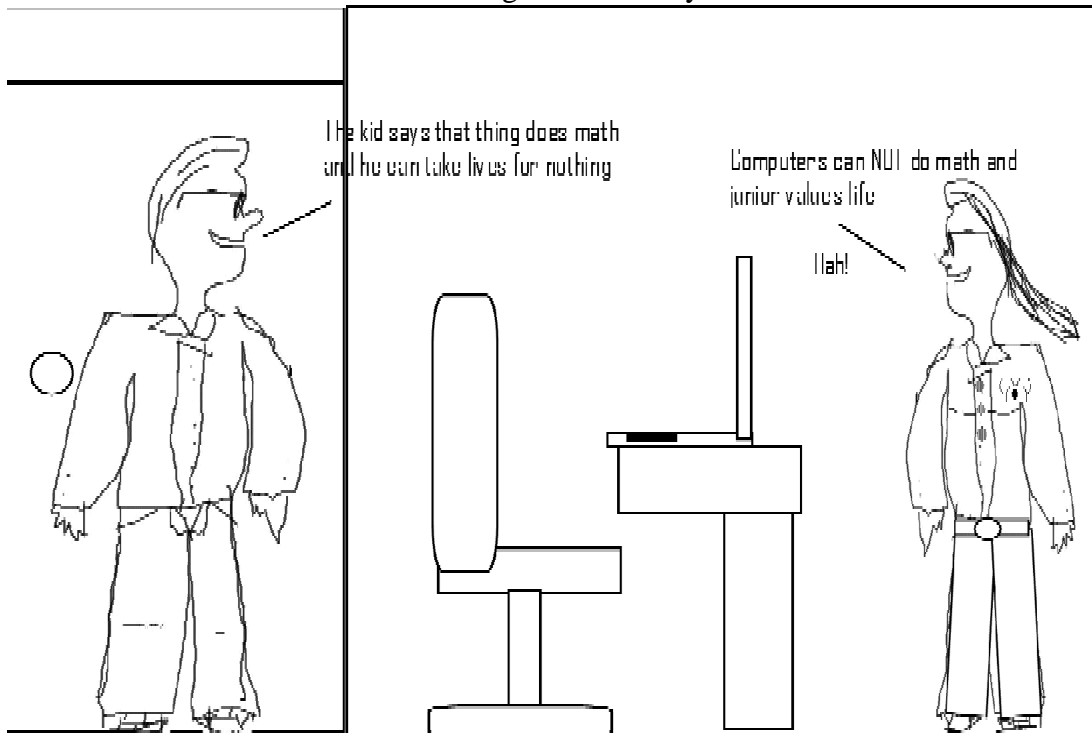

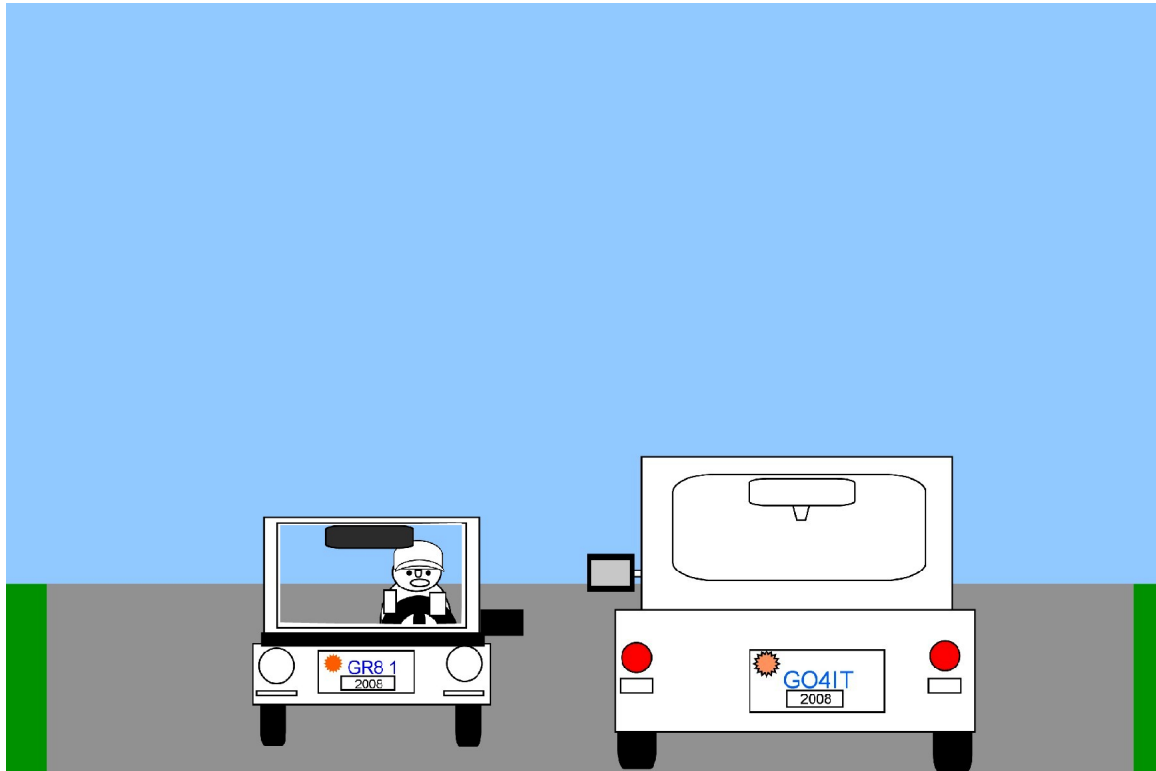
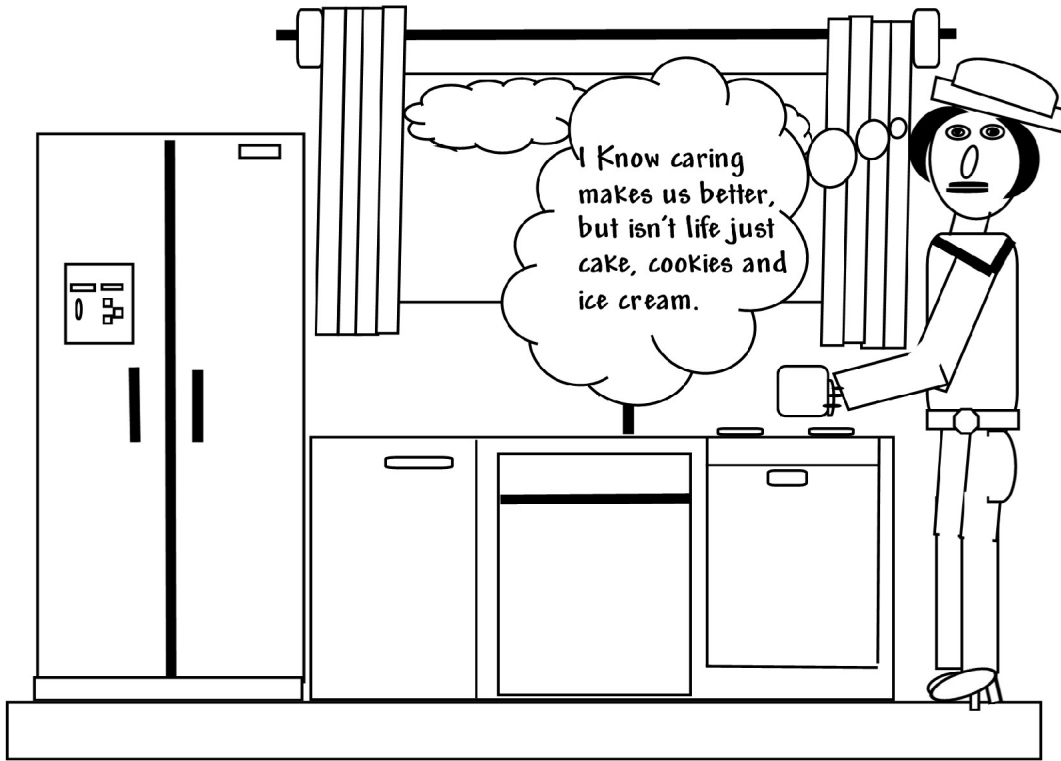



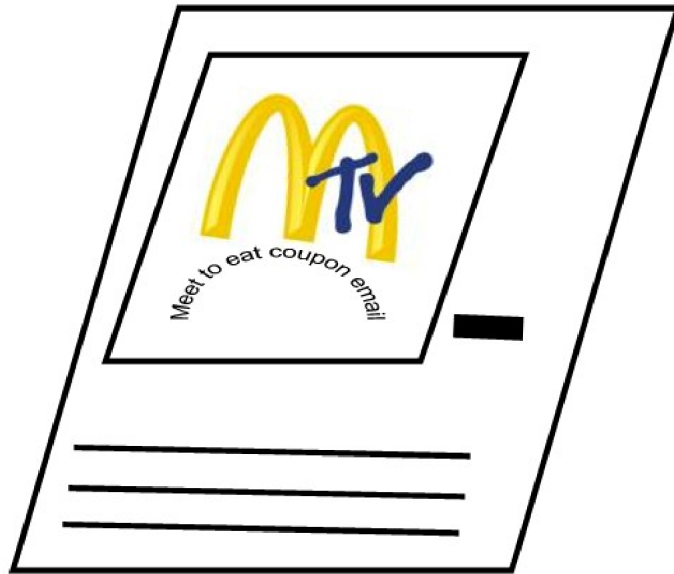
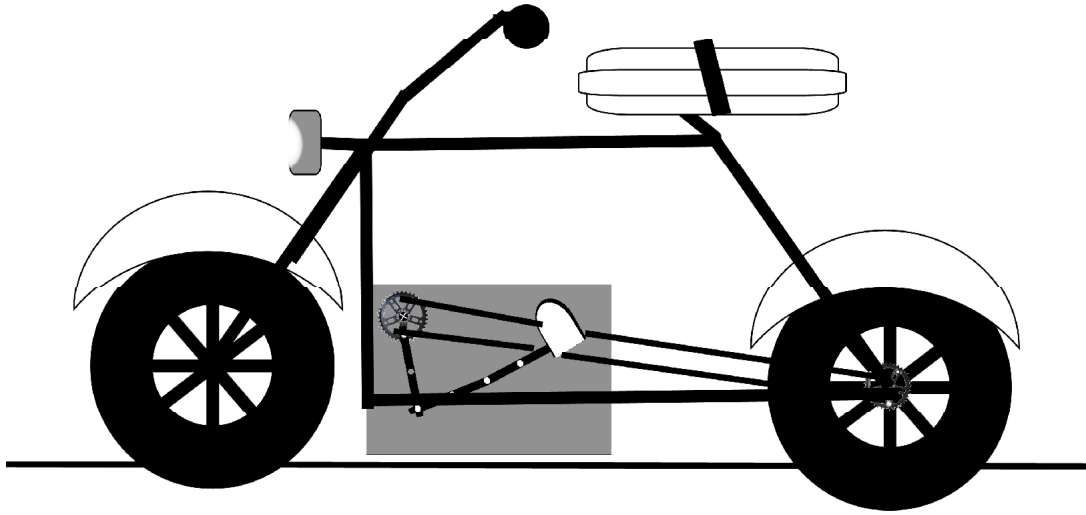

McEmail

Send a coupon with a 255 character message. Each McEmail system individually owned and operated

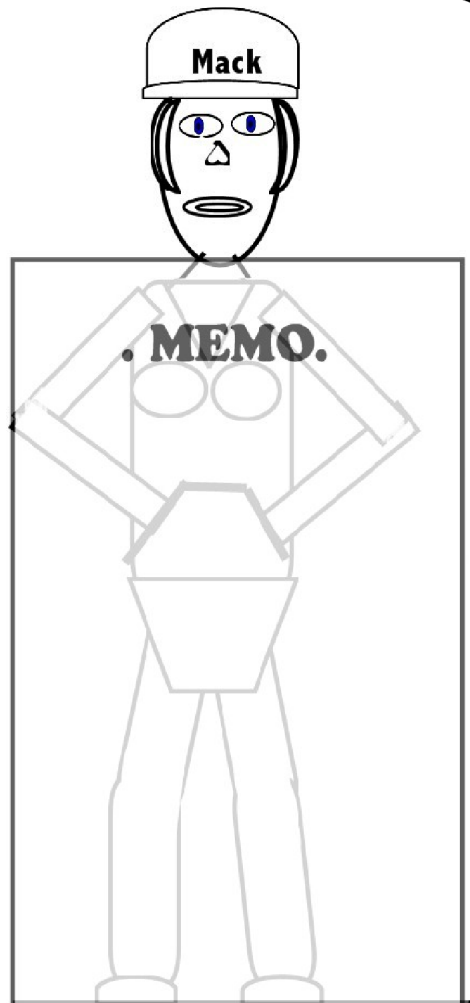
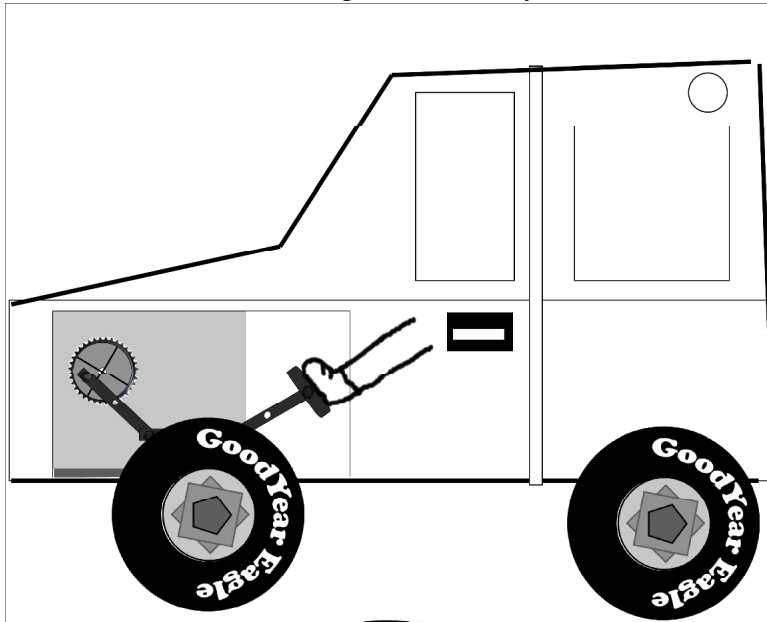

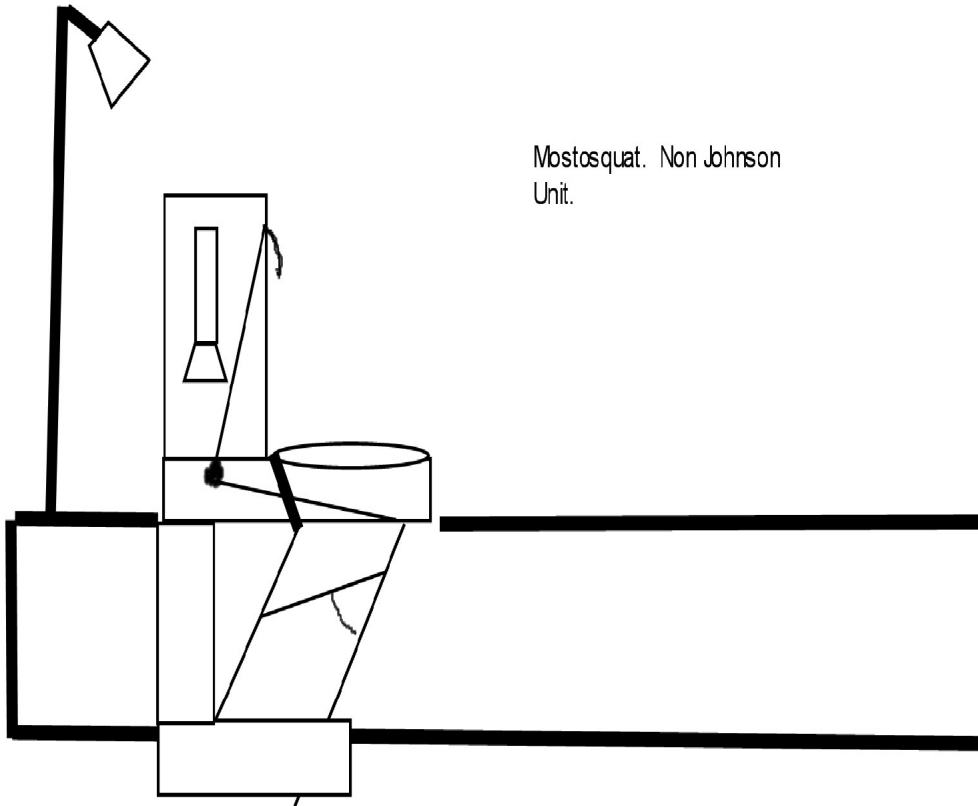

Mostosquat. Non Johnson  
Unit.

The back side scrape is the key to the new style toilet. Pre-Fill to see waste as normal. On completion use the sprayer. Auto spraying defeats the purpose. Women said life was to easy and had nothing to complain about. So I have given them the have you prefilled the bowl dear.

**The copy loses something each generation.**

